

SUPER[®]

SUPER[®] X7DB8
SUPER[®] X7DBE

USER'S MANUAL

Revision 1.1b

The information in this User's Manual has been carefully reviewed and is believed to be accurate. The vendor assumes no responsibility for any inaccuracies that may be contained in this document, makes no commitment to update or to keep current the information in this manual, or to notify any person or organization of the updates.

Please Note: For the most up-to-date version of this manual, please see our web site at www.supermicro.com.

Super Micro Computer, Inc. ("Supermicro") reserves the right to make changes to the product described in this manual at any time and without notice. This product, including software, if any, and documentation may not, in whole or in part, be copied, photocopied, reproduced, translated or reduced to any medium or machine without prior written consent.

IN NO EVENT WILL SUPERMICRO COMPUTER, INC. BE LIABLE FOR DIRECT, INDIRECT, SPECIAL, INCIDENTAL, OR CONSEQUENTIAL DAMAGES ARISING FROM THE USE OR INABILITY TO USE THIS PRODUCT OR DOCUMENTATION, EVEN IF ADVISED OF THE POSSIBILITY OF SUCH DAMAGES. IN PARTICULAR, SUPERMICRO COMPUTER SHALL NOT HAVE LIABILITY FOR ANY HARDWARE, SOFTWARE, OR DATA STORED OR USED WITH THE PRODUCT, INCLUDING THE COSTS OF REPAIRING, REPLACING, INTEGRATING, INSTALLING OR RECOVERING SUCH HARDWARE, SOFTWARE, OR DATA.

Any disputes arising between manufacturer and customer shall be governed by the laws of Santa Clara County in the State of California, USA. The State of California, County of Santa Clara shall be the exclusive venue for the resolution of any such disputes. Supermicro's total liability for all claims will not exceed the price paid for the hardware product.

FCC Statement: This equipment has been tested and found to comply with the limits for a Class A digital device pursuant to Part 15 of the FCC Rules. These limits are designed to provide reasonable protection against harmful interference when the equipment is operated in a commercial environment. This equipment generates, uses, and can radiate radio frequency energy and, if not installed and used in accordance with the manufacturer's instruction manual, may cause harmful interference with radio communications. Operation of this equipment in a residential area is likely to cause harmful interference, in which case you will be required to correct the interference at your own expense.

California Best Management Practices Regulations for Perchlorate Materials: This Perchlorate warning applies only to products containing CR (Manganese Dioxide) Lithium coin cells. "Perchlorate Material-special handling may apply. See www.dtsc.ca.gov/hazardouswaste/perchlorate"

WARNING: Handling of lead solder materials used in this product may expose you to lead, a chemical known to the State of California to cause birth defects and other reproductive harm.

Manual Revision: Rev. 1.1b

Release Date: October 3, 2008

Unless you request and receive written permission from Super Micro Computer, Inc., you may not copy any part of this document.

Information in this document is subject to change without notice. Other products and companies referred to herein are trademarks or registered trademarks of their respective companies or mark holders.

Copyright © 2008 by Super Micro Computer, Inc.
All rights reserved.

Printed in the United States of America

Preface

About This Manual

This manual is written for system integrators, PC technicians and knowledgeable PC users. It provides information for the installation and use of the **SUPER** X7DB8/X7DBE motherboard. The **SUPER** X7DB8/X7DBE supports dual Intel Xeon 64-bit quad-core/dual-core processors at a front side bus speed of 1333/1066/667 MHz. With dual Xeon 64-bit quad-core/dual-core processors, the 5000P (Blackford) chipset, and eight DDR2 FBD 667/533 memory modules built-in, the X7DB8/X7DBE offers substantial functionality and performance enhancements to the motherboards based on the NetBurst microarchitecture while remaining compatible with the 32-bit based software. Key features include Intel's Hyper-Threading Technology, Virtualization Technology, Hyper Pipelined Technology, Execution Trace Cache, Thermal Monitor 1/2 (TM1/TM2), Enhanced Intel SpeedStep technology, Advanced Dynamic Execution, Advanced Transfer Cache, Streaming SIMD Extensions 3 (SSE3) and Extended Memory 64 Technology (EM64T). These features allow the motherboard to operate at much higher speeds with better power management in much safer environments than the traditional motherboards. The X7DB8/X7DBE is ideal for high performance dual processor (DP) enterprise server/workstation environments. This product is intended to be professionally installed.

Manual Organization

Chapter 1 describes the features, specifications and performance of the mainboard and provides detailed information about the chipset.

Chapter 2 provides hardware installation instructions. Read this chapter when installing the processor, memory modules and other hardware components into the system. If you encounter any problems, see **Chapter 3**, which describes troubleshooting procedures for the video, the memory and the system setup stored in the CMOS.

Chapter 4 includes an introduction to BIOS and provides detailed information on running the CMOS Setup utility.

Appendix A and **Appendix B** provide BIOS POST Messages and POST Codes. **Appendix C**, **Appendix D** and **Appendix E** list HostRAID Setup Guidelines and Other Software Driver and Program Installation Instructions.

Conventions Used in the Manual:

Special attention should be given to the following symbols for proper installation and to prevent damage done to the components or injury to yourself:



Danger/ Caution: Instructions to be strictly followed to prevent catastrophic system failure or to avoid bodily injury.



Warning: Important information given to ensure proper system installation or to prevent damage to the components.

Note: Additional Information given to differentiate various models or to ensure correct system setup.

Table of Contents

Preface

About This Manual	iii
Manual Organization	iii
Conventions Used in the Manual	iii

Chapter 1: Introduction

1-1 Overview	1-1
Checklist	1-1
Contacting Supermicro	1-2
SUPER X7DB8/X7DBE Image	1-3
SUPER X7DB8/X7DBE Layout	1-4
Quick Reference	1-5
Motherboard Features.....	1-6
Intel 5000P (Blackford) Chipset: System Block Diagram	1-8
1-2 Chipset Overview	1-9
1-3 Special Features	1-10
Recovery from AC Power Loss	1-10
1-4 PC Health Monitoring	1-10
1-5 ACPI Features	1-11
1-6 Power Supply	1-12
1-7 Super I/O	1-13

Chapter 2: Installation

2-1 Static-Sensitive Devices	2-1
Precautions.....	2-1
Unpacking	2-1
2-2 Processor and Heatsink Installation	2-2
2-3 Installing DIMMs	2-6
2-4 Control Panel Connectors and IO Ports	2-8
A. Back Panel Connectors/IO Ports.....	2-8
B. Front Control Panel.....	2-9
C. Front Control Panel Pin Definitions	2-10
NMI Button	2-10
Power LED	2-10
HDD LED	2-11
NIC1/NIC2 LEDs	2-11
Overheat/Fan Fail LED	2-12
Power Fail LED	2-12

Reset Button	2-13
Power Button	2-13
2-5 Connecting Cables	2-14
ATX Power Connector	2-14
Processor Power Connector	2-14
Universal Serial Bus (USB0/1).....	2-15
Chassis Intrusion	2-15
Fan Headers	2-16
Keylock.....	2-16
ATX PS/2 Keyboard and Mouse Ports.....	2-17
Serial Ports	2-17
Wake-On-Ring.....	2-18
Wake-On-LAN	2-18
GLAN (Ethernet Ports).....	2-19
Speaker/Power LED Header	2-19
Power Fault	2-20
Alarm Reset.....	2-20
Overheat LED/Fan Fail	2-21
SMB Connector.....	2-21
SMB Power Connector.....	2-22
VGA Connector	2-22
Compact Flash Card PWR Connector.....	2-23
SGPIO Headers	2-23
2-6 Jumper Settings	2-24
Explanation of Jumpers	2-24
GLAN Enable/Disable	2-24
Clear CMOS	2-25
Watch Dog.....	2-25
SCSI Controller Enabled/Disabled	2-26
SCSI Termination Enabled/Dsiabled	2-26
3rd PWR Supply PWR Fault.....	2-27
VGA Enable/Disable.....	2-27
Compact Flash Master/Slave Enable/Disable.....	2-28
I ² C Bus to PCI-X-PCI-E Slots.....	2-28
2-7 Onboard Indicators	2-29
GLAN LEDs.....	2-29
Onboard SCSI Activity LED	2-30
Onboard Standby PWR LED.....	2-30

2-8 Parallel Port, Floppy, SIMLP IPMI, Hard Disk Drive and SCSI Connections ..	2-31
Parallel Port Connector	2-31
Floppy Connector	2-32
SIMLP IPMI Slot.....	2-32
IDE Connectors	2-33
Ultra 320 SCSI Connectors.....	2-34

Chapter 3: Troubleshooting

3-1 Troubleshooting Procedures	3-1
Before Power On.....	3-1
No Power.....	3-1
No Video	3-1
Memory Errors.....	3-1
Losing the System's Setup Configuration	3-1
3-2 Technical Support Procedures	3-2
3-3 Frequently Asked Questions	3-3
3-4 Returning Merchandise for Service	3-3

Chapter 4: BIOS

4-1 Introduction	4-1
4-2 Running Setup	4-2
4-3 Main BIOS Setup	4-2
4-4 Advanced Setup	4-7
4-5 Security Setup	4-24
4-6 Boot Setup.....	4-25
4-7 Exit.....	4-26

Appendices:

Appendix A: BIOS POST Messages	A-1
Appendix B: BIOS POST Codes.....	B-1
Appendix C: The Intel HostRAID Setup Guidelines.....	C-1
Appendix D: The Adaptec HostRAID Setup Guidelines.....	D-1
Appendix E: Installing Other Software Programs and Drivers.....	E-1

Chapter 1

Introduction

1-1 Overview

Checklist

Congratulations on purchasing your computer motherboard from an acknowledged leader in the industry. Supermicro boards are designed with the utmost attention to detail to provide you with the highest standards in quality and performance. Check that the following items have all been included with your motherboard. If anything listed here is damaged or missing, contact your retailer.

All the following items are included in the Retail Box.

- One (1) Supermicro Mainboard
- One (1) ribbon cable for IDE devices
- One (1) Serial Port cable
- One (1) USB cable
- One (1) floppy ribbon cable
- One (1) Ultra 320 SCSI cable (*X7DB8 only)
- Four (4) SATA cables (*X7DB8 only)
- Six (6) SATA cables (*X7DBE only)
- One (1) I/O backpanel shield
- One (1) Supermicro CD containing drivers and utilities
- One (1) User's/BIOS Manual
- One (1) Ultra 320 SCSI User's Manual (*X7DB8 only)

Contacting Supermicro

Headquarters

Address: Super Micro Computer, Inc.
980 Rock Ave.
San Jose, CA 95131 U.S.A.

Tel: +1 (408) 503-8000

Fax: +1 (408) 503-8008

Email: marketing@supermicro.com (General Information)
support@supermicro.com (Technical Support)

Web Site: www.supermicro.com

Europe

Address: Super Micro Computer B.V.
Het Sterrenbeeld 28, 5215 ML
's-Hertogenbosch, The Netherlands

Tel: +31 (0) 73-6400390

Fax: +31 (0) 73-6416525

Email: sales@supermicro.nl (General Information)
support@supermicro.nl (Technical Support)
rma@supermicro.nl (Customer Support)

Asia-Pacific

Address: Super Micro, Taiwan
4F, No. 232-1 Liancheng Road
Chung-Ho 235, Taipei Hsien, Taiwan, R.O.C.

Tel: +886-(2) 8226-3990

Fax: +886-(2) 8226-3991

Web Site: www.supermicro.com.tw

Technical Support:

Email: support@supermicro.com.tw

Tel: 886-2-8228-1366, ext.132 or 139

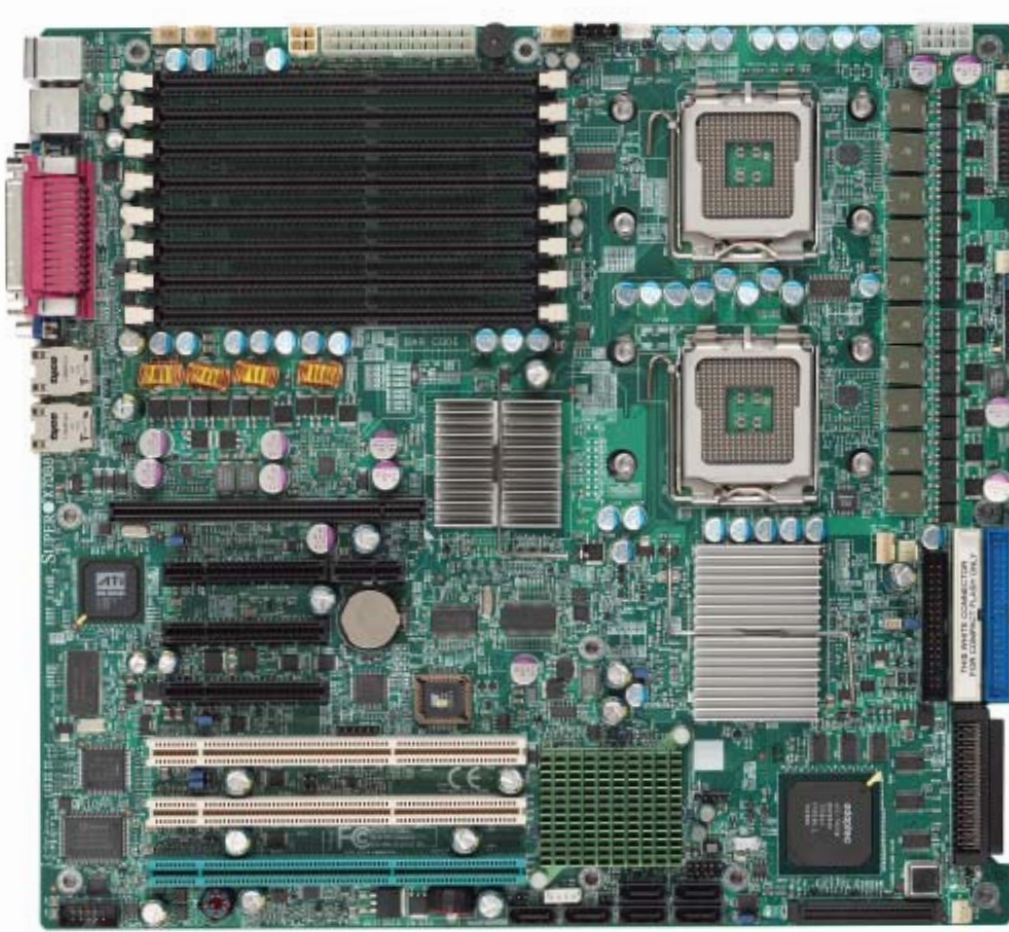
SUPER[®] X7DB8/X7DBE Image

(Note: The drawings and pictures shown in this manual were based on the latest PCB Revision available at the time of publishing of the manual. The motherboard you've received may or may not look exactly the same as the graphics shown in the manual.)

SUPER X7DB8/X7DBE Motherboard Layout

(not drawn to scale)

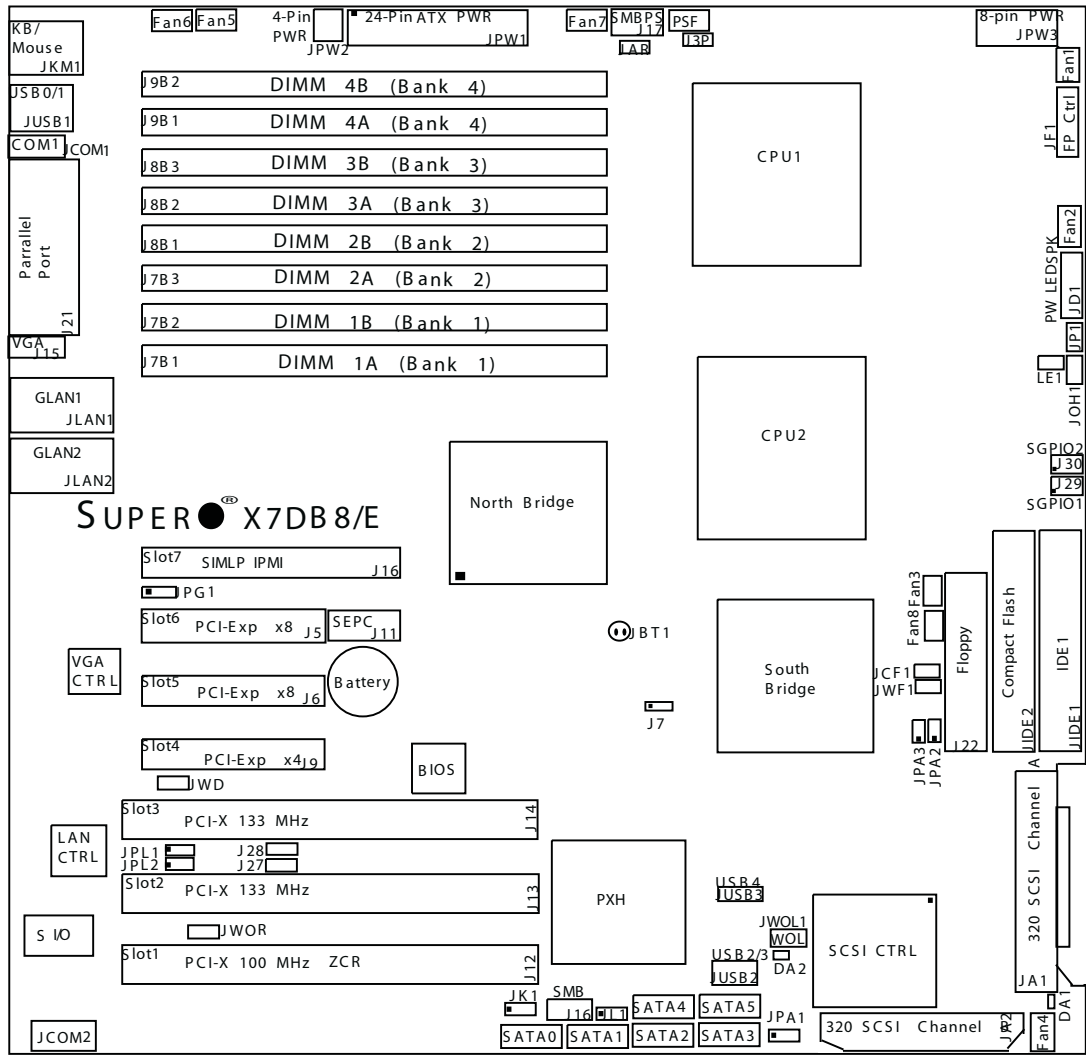

Notes

1. Jumpers not indicated are for test purposes only.
2. See Chapter 2 for detailed information on jumpers, I/O ports and JF1 front panel connections.
3. "■" indicates the location of Pin 1.
4. SCSI is for the X7DB8 only.
5. SEPC: Supermicro Enhanced Power Connector, specially designed to support Supermicro 2U Riser Card only.
6. When LE1 is on, make sure to turn off the power before removing or installing components.
7. For the ZCR card to function properly, be sure to install it in the green slot.

Quick Reference (X7DB8/X7DBE)

Jumper	Description	Default Setting
J27, J28	I ² C Bus to PCI-X/PCI-E Slots	Open (Disabled)
J3P	3rd PWR Failure Detect	Off (Disabled)
JBT1	CMOS Clear	See Chapter 2
JCF1	Compact Card Master/Slave Select	On (Master)
JPA1 (*X7DB8)	SCSI Controller Enable	Pins 1-2 (Enabled)
JPA2, JPA3	SCSI CHA(JPA2),CHB(JPA3)Term.En	Off (Enabled) (*X7DB8)
JPG1	VGA Enable	Pins 1-2 (Enabled)
JPL1/JPL2	GLAN1/GLAN2 Enable	Pins 1-2 (Enabled)
JWD	Watch Dog	Pins 1-2 (Reset)
Connector	Description	
ATX PWR (JPW1)	Primary 24-Pin ATX PWR Connector	
Aux. PWR/CPU PWR	+12V 4-pin PWR (JWP2)/+12V 8-pin PWR(JPW3)	
Alarm Reset (JAR)	Alarm Reset Off (Normal)	
Chassis Intrusion (JL1)	Chassis Intrusion Header	
COM1/COM2	COM1/COM2 Serial Port Connectors	
Compact PWR (JWF1)	Compact Card PWR Connector (*Used if JCF1 is on.)	
DA1/DA2	SCSI Activity LED Indicators (See Chapter 2)	
DIMM#1A-DIMM#4B	Memory FBD DDRII Slots	
FAN 1-8	Fans 1-8 (CPU Fans/Chassis Fans)	
Floppy (J22)	Floppy Disk Drive Connector	
FP CTRL (JF1)	Front Control Panel Connector	
GLAN 1/2 (JLAN1/2)	G-bit Ethernet Ports	
IDE1/IDE2 (Note)	IDE1 Hard Drive (JIDE1)/Compact Flash Card (JIDE2)	
Keylock (JK1)	Keylock Header	
OH LED (JOH1)	Overheat LED	
Parallel (J21)	Parallel (Printer) Port	
PSF	Power Supply Failure (See Chapter 2)	
PWR LED (LE1)	PWR LED Indicator (Note 6 on Pg.1-4)	
PWR LED/SPKR (JD1)	PWR LED(pins1-3)/SpeakerHeader (pins 4-7)	
PWR SMB (J17)	Power System Management (I ² C) Header	
SATA0-SATA5	SATA 0-5 Connectors	
SCSI Chan. A/B(JA1/JA2)	SCSI Channel A/Channel B Connectors (*X7DB8 only)	
SGPIO 1/2(J29,J30)	Serial General Purpose Input/Output Headers	
SMB (J18)	System Management Bus Header	
Slot 7	SIM Low Profile IPMI Connector	
USB 0/1,USB 2/3, USB4	Back Panel USB 0/1, Front Panel USB 2/3, FP USB4	
VGA (J15)	VGA Connector	
WOL (JWOL)	Wake-on-LAN Header	
WOR (JWOR)	Wake-on-Ring Header	

Note: JIDE2 is for Compact Card Use only. For Compact Card to work properly, please enable JCF1 by putting cap on it and connect JWF1 to a power supply.

Motherboard Features

CPU

- Dual Intel® 64-bit Xeon LGA 771 quad-core/dual-core processors at a front side bus speed of 1.333 GHz/1.066 GHz/667 MHz with a system clock speed of 333/267 MHz

Memory

- Eight 240-pin DIMM sockets with support up to 16 (32) GB DDR2 Fully Buffered (FBD) ECC 667/533 Memory (*See Section 2-3 in Chapter 2 for DIMM Slot Population.)

Chipset

- Intel 5000P (Blackford) chipset, including: the 5000P (Blackford) Memory Control Hub (MCH), the Enterprise South Bridge 2 (ESB2), and the I/O subsystem (PXH).

Expansion Slots

- Three PCI-Express slots (*two slots at x8@4GB/sec, one slot x4@2GB/sec.)
- Three 64-bit PCI-X slots (*two PCI-X-133 slots, one PCI-X-100 w/ZCR slot)

BIOS

- 8 Mb Phoenix® Flash ROM
- DMI 2.3, PCI 2.2, ACPI 1.0, Plug and Play (PnP)

PC Health Monitoring

- Onboard voltage monitors for CPU cores, chipset voltage, +3.3V, +5V, +12V, -12V and +5V standby
- Fan status monitor with firmware control
- CPU/chassis temperature monitors
- Platform Environment Control Interface (PECI) ready
- CPU fan auto-off in sleep mode
- CPU slow-down on temperature overheat
- CPU thermal trip support for processor protection, power LED
- Power-up mode control for recovery from AC power loss
- Auto-switching voltage regulator for CPU cores
- System overheat/Fan Fail LED Indicator and control
- Chassis intrusion detection
- System resource alert via Supero Doctor III

ACPI Features

- Slow blinking LED for suspend state indicator
- Main switch override mechanism
- ACPI/ACPM Power Management
- Keyboard Wakeup from Soft-off

Onboard I/O

- Adaptec 7902 dual channel Ultra 320 SCSI with ZCR option (X7DB8 only)
- Six SATA2 ports (supporting RAID0, RAID1,10 and 5)
- One SIMLP IPMI socket
- Intel 82563 Gigabit Ethernet controller supporting two Giga-bit LAN ports
- Two EIDE Ultra DMA/100 bus master interfaces supporting one IDE (the blue slot) and one Compact Flash card (the blue slot)
- Two SGPIO (Serial General Purpose Input/Output) headers
- One floppy port interface
- Two COM ports (1 header, 1 port)
- One EPP/ECP Parallel Port
- PS/2 mouse and PS/2 keyboard ports
- Up to five USB 2.0 (Universal Serial Bus) (2 ports, 3 Headers)
- ATI ES1000 with 16 MB Graphic Controller
- Super I/O: Winbond W83627HF w/Hardware Monitor support: W83793, HECETA

Other

- External modem ring-on
- Wake-on-LAN (WOL)
- Wake-on-Ring (WOR)
- Console redirection
- Onboard Fan Speed Control by Thermal Management via BIOS

CD/Diskette Utilities

- BIOS flash upgrade utility and device drivers

Dimensions

- Ext. ATX 13.5" x 13.05" (342.90 x 331.5 mm)

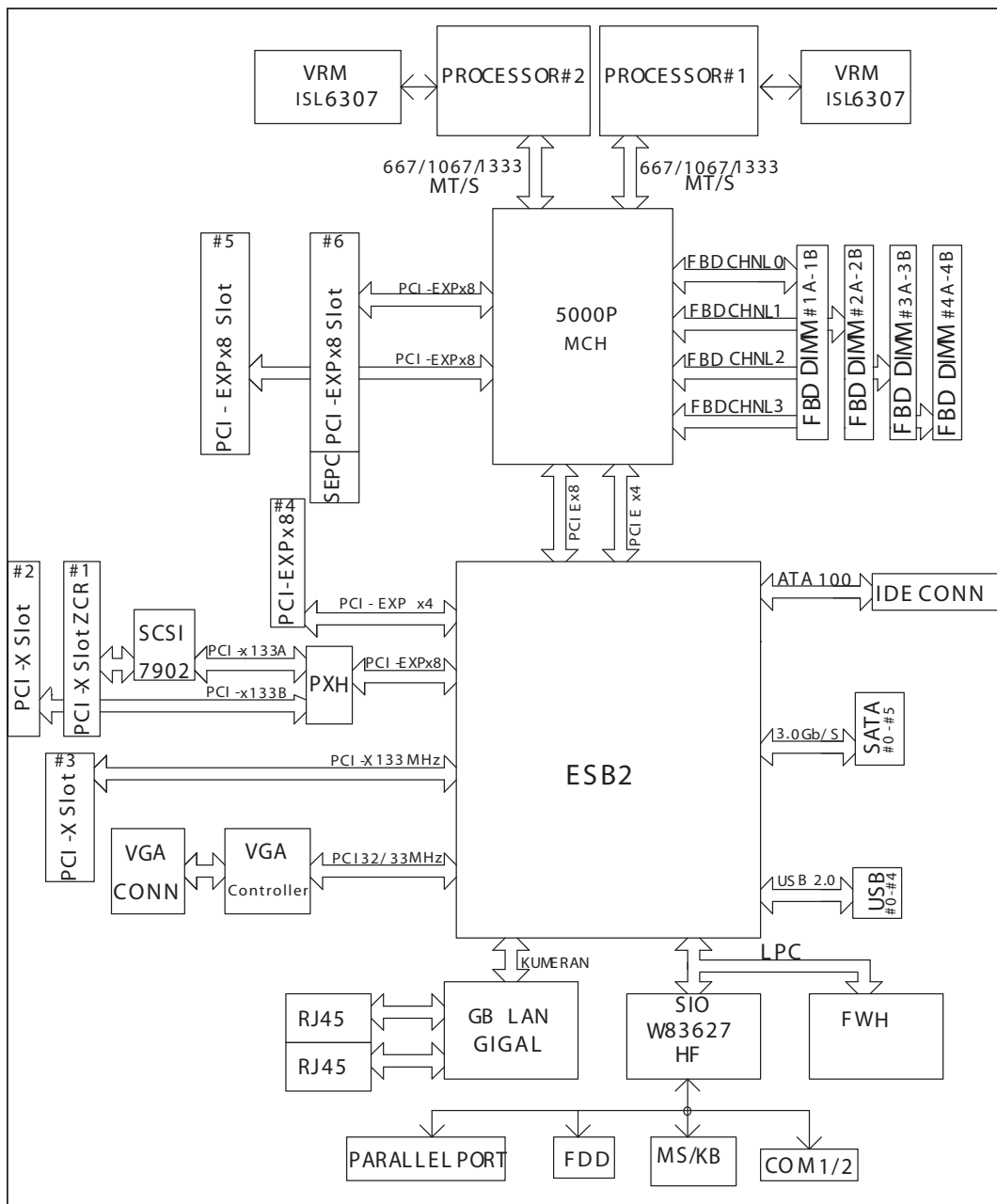

Block Diagram of the 5000P (Blackford) Chipset

Note: This is a general block diagram. Please see the previous Motherboard Features pages for details on the features of each motherboard.

1-2 Chipset Overview

Built upon the functionality and the capability of the 5000P (Blackford) chipset, the X7DB8/X7DBE motherboard provides the performance and feature set required for dual processor-based servers with configuration options optimized for communications, presentation, storage, computation or database applications. The 5000P (Blackford) chipset supports single or dual Xeon 64-bit quad-core/dual-core processor(s) with front side bus speeds of up to 1.333 GHz. The chipset consists of the 5000P (Blackford) Memory Controller Hub (MCH), the Enterprise South Bridge 2 (ESB2), and the I/O subsystem (PXH).

The 5000P (Blackford) MCH chipset is designed for symmetric multiprocessing across two independent front side bus interfaces. Each front side bus uses a 64-bit wide, 1333 MHz data bus that transfers data at 10.7 GB/sec. In addition, the 5000P (Blackford) chipset offers a wide range of RAS features, including memory interface ECC, x4/x8 Single Device Data Correction, CRC, parity protection, memory mirroring and memory sparing.

The Xeon Quad-core/dual-core Processor Features

Designed to be used with conjunction of the 5000P (Blackford) chipset, the Xeon quad-core/dual-core Processor provides a feature set as follows:

The Xeon Quad-core/dual-core Processors

*L1 Cache Size: Instruction Cache (32KB/16KB), Data Cache (32KB/24KB)

*L2 Cache Size: 4MB/2MB (per core)

*Data Bus Transfer Rate: 8.5 GB/s

*Package: FC-LGA6/FC-LGA4, 771 Lands

1-3 Special Features

Recovery from AC Power Loss

BIOS provides a setting for you to determine how the system will respond when AC power is lost and then restored to the system. You can choose for the system to remain powered off (in which case you must hit the power switch to turn it back on) or for it to automatically return to a power-on state. See the Power Lost Control setting in the Advanced BIOS Setup section to change this setting.

1-4 PC Health Monitoring

This section describes the PC health monitoring features of the X7DB8/X7DBE. All have an onboard System Hardware Monitor chip that supports PC health monitoring.

Onboard Voltage Monitors for CPU Core, +3.3V, +5V, +12V, -12V and +5V standby

An onboard voltage monitor will scan these voltages continuously. Once a voltage becomes unstable, a warning is given or an error message is sent to the screen. Users can adjust the voltage thresholds to define the sensitivity of the voltage monitor.

Fan Status Monitor with Firmware Control

The PC health monitor can check the RPM status of the cooling fans. The onboard CPU and chassis fans are controlled by Thermal Management via BIOS (under Hardware Monitoring in the Advanced Setting).

Environmental Temperature Control

The thermal control sensor monitors the CPU temperature in real time and will turn on the thermal control fan whenever the CPU temperature exceeds a user-defined threshold. The overheat circuitry runs independently from the CPU. Once it detects that the CPU temperature is too high, it will automatically turn on the thermal fan control to prevent any overheat damage to the CPU. The onboard chassis thermal circuitry can monitor the overall system temperature and alert users when the chassis temperature is too high.

CPU Fan Auto-Off in Sleep Mode

The CPU fan activates when the power is turned on. It continues to operate when the system enters Standby mode. When in sleep mode, the CPU will not run at full power, thereby generating less heat.

CPU Overheat LED and Control

This feature is available when the user enables the CPU overheat warning function in the BIOS. This allows the user to define an overheat temperature. When this temperature is exceeded, both the overheat fan and the warning LED are triggered.

System Resource Alert

This feature is available when used with Supero Doctor III in the Windows OS environment or used with Supero Doctor II in Linux. Supero Doctor is used to notify the user of certain system events. For example, you can also configure Supero Doctor to provide you with warnings when the system temperature, CPU temperatures, voltages and fan speeds go beyond a pre-defined range.

1-5 ACPI Features

ACPI stands for Advanced Configuration and Power Interface. The ACPI specification defines a flexible and abstract hardware interface that provides a standard way to integrate power management features throughout a PC system, including its hardware, operating system and application software. This enables the system to automatically turn on and off peripherals such as CD-ROMs, network cards, hard disk drives and printers. This also includes consumer devices connected to the PC such as VCRs, TVs, telephones and stereos.

In addition to enabling operating system-directed power management, ACPI provides a generic system event mechanism for Plug and Play and an operating system-independent interface for configuration control. ACPI leverages the Plug and Play BIOS data structures while providing a processor architecture-independent implementation that is compatible with both Windows 2000, Windows XP and Windows 2003 Servers.

Slow Blinking LED for Suspend-State Indicator

When the CPU goes into a suspend state, the chassis power LED will start blinking to indicate that the CPU is in suspend mode. When the user presses any key, the CPU will wake-up and the LED will automatically stop blinking and remain on.

Main Switch Override Mechanism

When an ATX power supply is used, the power button can function as a system suspend button to make the system enter a SoftOff state. The monitor will be suspended and the hard drive will spin down. Pressing the power button again will cause the whole system to wake-up. During the SoftOff state, the ATX power supply provides power to keep the required circuitry in the system alive. In case the system malfunctions and you want to turn off the power, just press and hold the power button for 4 seconds. This option can be set in the Power section of the BIOS Setup routine.

External Modem Ring-On

Wake-up events can be triggered by a device such as the external modem ringing when the system is in the SoftOff state. Note that external modem ring-on can only be used with an ATX 2.01 (or above) compliant power supply.

Wake-On-LAN (WOL)

Wake-On-LAN is defined as the ability of a management application to remotely power up a computer that is powered off. Remote PC setup, up-dates and asset tracking can occur after hours and on weekends so that daily LAN traffic is kept to a minimum and users are not interrupted. The motherboard has a 3-pin header (WOL) to connect to the 3-pin header on a Network Interface Card (NIC) that has WOL capability. In addition, an onboard LAN controller can also support WOL without any connection to the WOL header. The 3-pin WOL header is to be used with a LAN add-on card only.

Note: Wake-On-LAN requires an ATX 2.01 (or above) compliant power supply.

1-6 Power Supply

As with all computer products, a stable power source is necessary for proper and reliable operation. It is even more important for processors that have high CPU clock rates.

The X7DB8/X7DBE can only accommodate 24-pin ATX power supplies. Although most power supplies generally meet the specifications required by the CPU, some are inadequate. In addition, the 12V 4-pin power supply - is also required to ensure adequate power supply to the system. Also your power supply must supply 1.5A for the Ethernet ports.

Note: The + 12V 8-pin Aux. Power Connector is also required to support Intel 64-bit CPUs. Failure to provide this extra power will result in CPU PWR Failure. See Section 2-5 for details on connecting the power supply.

It is strongly recommended that you use a high quality power supply that meets ATX power supply Specification 2.02 or above. It must also be SSI compliant (info at <http://www.ssiforum.org/>). Additionally, in areas where noisy power transmission is present, you may choose to install a line filter to shield the computer from noise. It is recommended that you also install a power surge protector to help avoid problems caused by power surges.

1-7 Super I/O

The disk drive adapter functions of the Super I/O chip include a floppy disk drive controller that is compatible with industry standard 82077/765, a data separator, write pre-compensation circuitry, decode logic, data rate selection, a clock generator, drive interface control logic and interrupt and DMA logic. The wide range of functions integrated onto the Super I/O greatly reduces the number of components required for interfacing with floppy disk drives. The Super I/O supports 360 K, 720 K, 1.2 M, 1.44 M or 2.88 M disk drives and data transfer rates of 250 Kb/s, 500 Kb/s or 1 Mb/s. It also provides two high-speed, 16550 compatible serial communication ports (UARTs). Each UART includes a 16-byte send/receive FIFO, a programmable baud rate generator, complete modem control capability and a processor interrupt system. Both UARTs provide legacy speed with baud rate of up to 115.2 Kbps as well as an advanced speed with baud rates of 250 K, 500 K, or 1 Mb/s, which support higher speed modems.

The Super I/O supports one PC-compatible printer port (SPP), Bi-directional Printer Port (BPP) , Enhanced Parallel Port (EPP) or Extended Capabilities Port (ECP).

The Super I/O provides functions that comply with ACPI (Advanced Configuration and Power Interface), which includes support of legacy and ACPI power management through an SMI or SCI function pin. It also features auto power management to reduce power consumption.

Notes

Chapter 2

Installation

2-1 Static-Sensitive Devices

Electro-Static-Discharge (ESD) can damage electronic components. To prevent damage to your system board, it is important to handle it very carefully. The following measures are generally sufficient to protect your equipment from ESD.

Precautions

- Use a grounded wrist strap designed to prevent static discharge.
- Touch a grounded metal object before removing the board from the antistatic bag.
- Handle the board by its edges only; do not touch its components, peripheral chips, memory modules or gold contacts.
- When handling chips or modules, avoid touching their pins.
- Put the motherboard and peripherals back into their antistatic bags when not in use.
- For grounding purposes, make sure your computer chassis provides excellent conductivity between the power supply, the case, the mounting fasteners and the motherboard.
- Use only the correct type of onboard CMOS battery as specified by the manufacturer. Do not install the onboard battery upside down to avoid possible explosion.

Unpacking

The motherboard is shipped in antistatic packaging to avoid static damage. When unpacking the board, make sure the person handling it is static protected.

2-2 Processor and Heatsink Installation



When handling the processor package, avoid placing direct pressure on the label area of the fan.

(Notes: 1. Always connect the power cord last and always remove it before adding, removing or changing any hardware components. Make sure that you install the processor into the CPU socket before you install the CPU heatsink.

2. Intel's boxed Xeon CPU package contains the CPU fan and heatsink assembly. If you buy a CPU separately, make sure that you use only Intel-certified multi-directional heatsink and fan.

3. The Intel Xeon LGA 771 heatsink and fan comes with a push-pin design and no tool is needed for installation.

4. Make sure to install the motherboard into the chassis before you install the CPU heatsink and fan.)

5. When purchasing an LGA 771 CPU or when receiving a motherboard with an LGA 771 CPU pre-installed, make sure that the CPU plastic cap is in place and none of the CPU pins are bent; otherwise, contact the retailer immediately.

6. Refer to the MB Features Section for more details on CPU support.

Installation of the LGA771 Processor

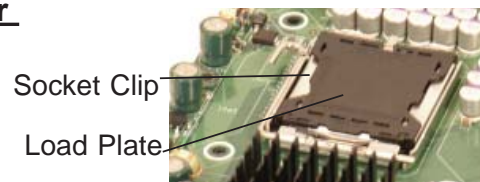

1. Press the socket clip to release the load plate, which covers the CPU socket, from its locking position.



2. Gently lift the socket clip to open the load plate.

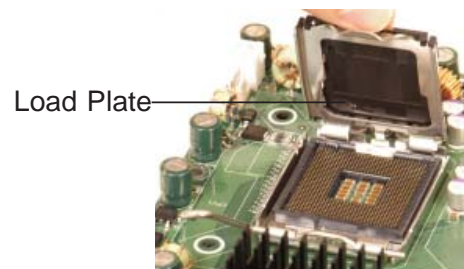

3. Use your thumb and your index finger to hold the CPU at the North Center Edge and the South Center Edge of the CPU.

4. Align CPU Pin1 (the CPU corner marked with a triangle) against the socket corner that is marked with a triangle cutout.

5. Align the CPU key that is the semi-circle cutout below a gold dot against the socket key, the notch on the same side of the triangle cutout on the socket.

6. Once aligned, carefully lower the CPU straight down to the socket. (Do not drop the CPU on the socket or move the CPU horizontally or vertically. Do not rub the CPU against the surface or against any pins of the socket to avoid damage to the CPU or the socket.)

7. With the CPU inside the socket, inspect the four corners of the CPU to make sure that the CPU is properly installed.

8. Use your thumb to gently push the socket clip down to the clip lock.

9. If the CPU is properly installed into the socket, the plastic cap will be automatically released from the load plate when the clip is pushed in the clip lock. Remove the plastic cap from the motherboard.

 **(Warning:** Please save the plastic cap. The motherboard must be shipped with the plastic cap properly installed to protect the CPU socket pins. Shipment without the plastic cap properly installed will cause damage to the socket pins.)

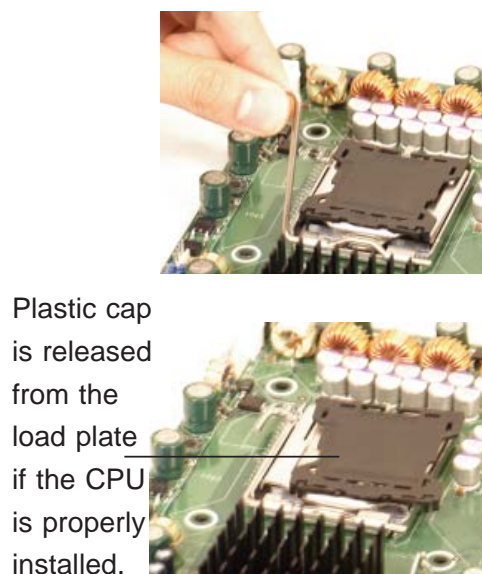
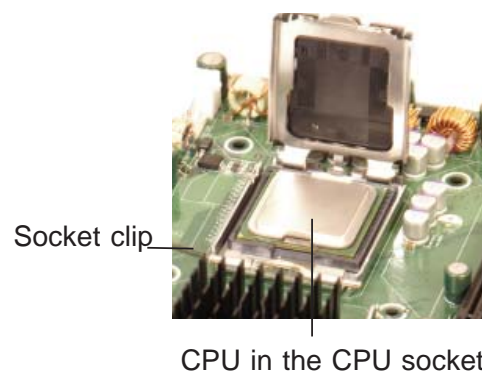
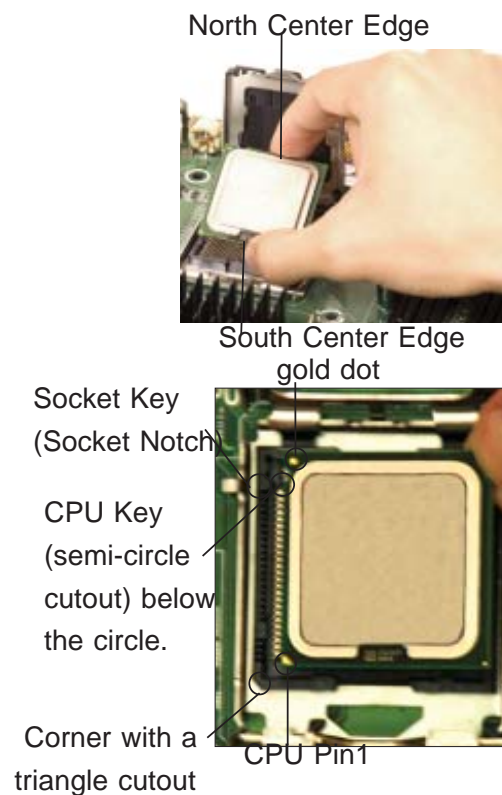

CEK Heatsink Installation

Installation of the Heatsink

1. Do not apply any thermal grease to the heatsink or the CPU die-the required amount has already been applied.

2. Place the heatsink on top of the CPU so that the four mounting holes are aligned with those on the retention mechanism.

3. Screw in two diagonal screws (ie the #1 and the #2 screws) until just snug (-do not fully tighten the screws to avoid possible damage to the CPU.)

4. Finish the installation by fully tightening all four screws.

CEK Passive Heatsink

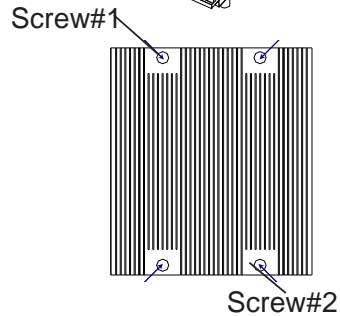
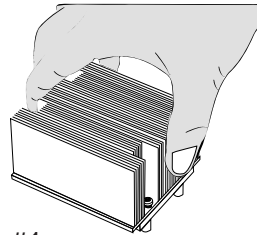
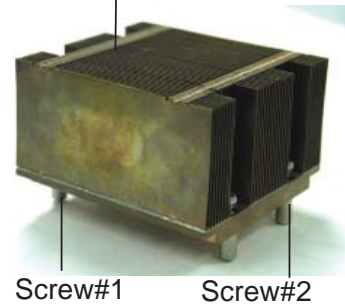

To Un-install the Heatsink



(Warning: We do not recommend that the CPU or the heatsink be removed. However, if you do need to uninstall the heatsink, please follow the instructions below to uninstall the heatsink to prevent damage done to the CPU or the CPU socket.)

1. Unscrew and remove the heatsink screws from the motherboard in the sequence as show in the picture on the right.

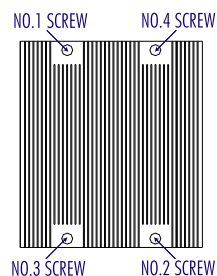

2. Hold the heatsink as shown in the picture on the right and gently wriggle the heatsink to loosen it from the CPU. (Do not use excessive force when wriggling the heatsink!!)

3. Once the CPU is loosened, remove the heatsink from the CPU socket.

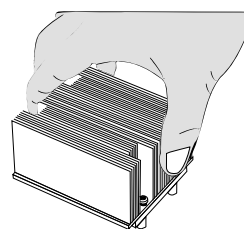

4. Clean the surface of the CPU and the heatsink to get rid of the old thermal grease. Reapply the proper amount of thermal grease on the surface before you re-install the CPU and the heatsink.

Mounting the Motherboard in the Chassis

All motherboards have standard mounting holes to fit different types of chassis. Make sure that the locations of all the mounting holes for both motherboard and chassis match. Make sure that the metal standoffs click in or are screwed in tightly. Then, use a screwdriver to secure the motherboard onto the motherboard tray. (Note: some components are very close to the mounting holes. Please take precautionary measures to prevent damage done to these components when you install the motherboard to the chassis.)

2-3 Installing DIMMs

Note: Check the Supermicro web site for recommended memory modules.



CAUTION

Exercise extreme care when installing or removing DIMM modules to prevent any possible damage. Also note that the memory is interleaved to improve performance (See step 1).

DIMM Installation (See Figure 2-2)

1. Insert the desired number of DIMMs into the memory slots, starting with DIMM #1A. The memory scheme is interleaved so you must install two modules at a time, beginning with DIMM #1A, then DIMM #2A and so on. (*See the Memory Installation Table Below.)
2. Insert each DIMM module vertically into its slot. Pay attention to the notch along the bottom of the module to prevent inserting the DIMM module incorrectly.
3. Gently press down on the DIMM module until it snaps into place in the slot. Repeat for all modules (see step 1 above).

Memory Support

The X7DB8/X7DBE supports up to 16 GB (32 GB) fully buffered (FBD) ECC DDR2 533/667 in 8 DIMMs. Populating DIMM modules with pairs of memory modules of the same size and same type will result in Interleaved Memory which will increase memory performance.

Note 1: Due to OS limitations, some operating systems may not show more than 4 GB of memory.

Optimized DIMM Population Configurations								
	Branch0				Branch1			
Number of DIMMs	Bank 1 (Channel 0)		Bank 2 (Channel 1)		Bank 3 (Channel 2)		Bank 4 (Channel 3)	
2 DIMMs	1A	-----	2A	-----	-----	-----	-----	-----
4 DIMMs	1A	-----	2A	-----	3A	-----	4A	-----
6 DIMMs	1A	1B	2A	2B	3A	-----	4A	-----
8 DIMMs	1A	1B	2A	2B	3A	3B	4A	4B

(*Notes: i. DIMM slot# specified: DIMM slot to be populated; "----": DIMM slot not to be populated. ii. Both FBD 533 MHz and 667MHz DIMMs are supported; however, you need to use the memory modules of the same speed and of the same type on a motherboard. iii. Interleaved memory is supported when pairs of DIMM modules are installed. To optimize memory performance, please install pairs of DIMMs in **both Branch 0 and Branch 1**. iv. For memory to work properly, you need to follow the restrictions listed above.)

Note 2: Due to memory allocation to system devices, memory remaining available for operational use will be reduced when 4 GB of RAM is used. The reduction in memory availability is disproportional. (Refer to the following Memory Availability Table for details.

Possible System Memory Allocation & Availability		
System Device	Size	Physical Memory Remaining (-Available) (4 GB Total System Memory)
Firmware Hub flash memory (System BIOS)	1 MB	3.99
Local APIC	4 KB	3.99
Area Reserved for the chipset	2 MB	3.99
I/O APIC (4 Kbytes)	4 KB	3.99
PCI Enumeration Area 1	256 MB	3.76
PCI Express (256 MB)	256 MB	3.51
PCI Enumeration Area 2 (if needed) -Aligned on 256-MB boundary-	512 MB	3.01
VGA Memory	16 MB	2.85
TSEG	1 MB	2.84
Memory available to OS and other applications		2.84

Figure 2-2. Installing and Removing DIMMs

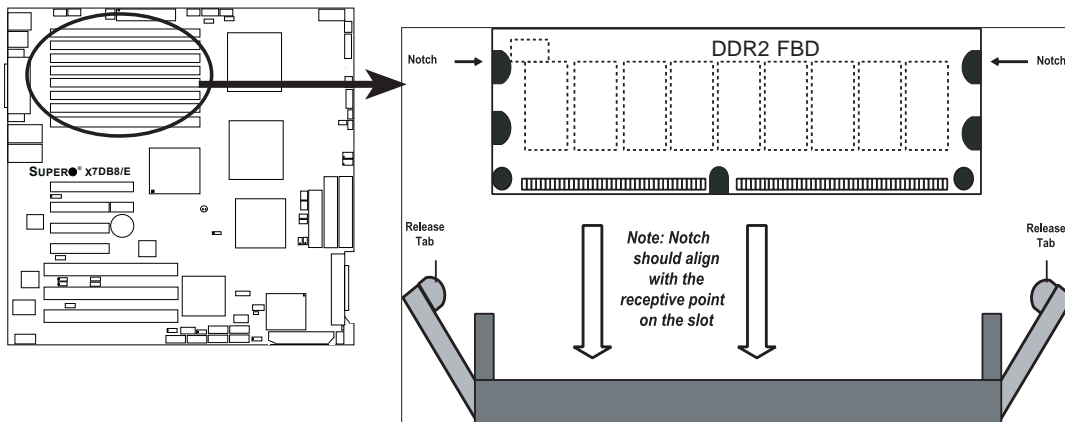

To Install: Insert module vertically and press down until it snaps into place. Pay attention to the alignment notch at the bottom.

To Remove:
Use your thumbs to gently push the release tabs near both ends of the module. This should release it from the slot.

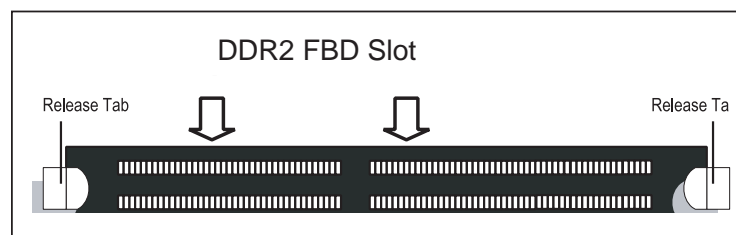

2-4 Control Panel Connectors/IO Ports

The I/O ports are color coded in conformance with the PC 99 specification. See Figure 2-3 below for the colors and locations of the various I/O ports.

A. Back Panel Connectors/IO Ports

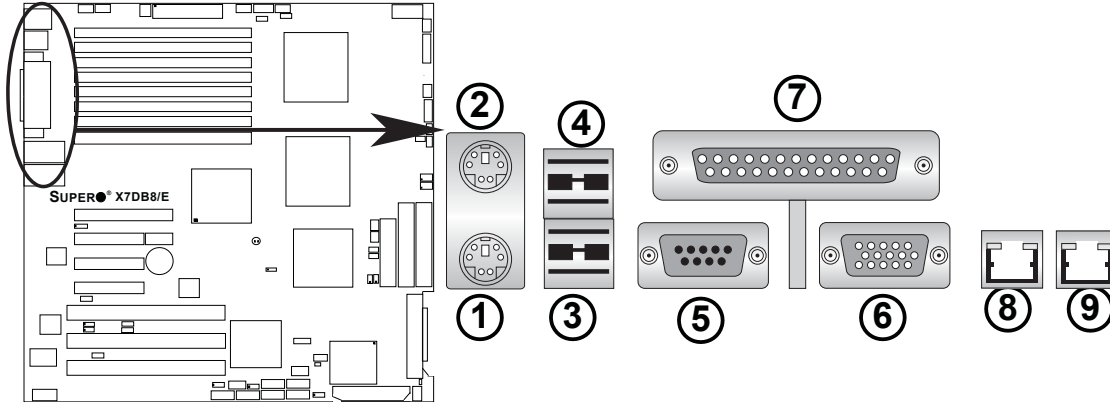

Figure 2-3. Back Panel I/O Port Locations and Definitions

Back Panel Connectors

1. Keyboard (Purple)
2. PS/2 Mouse (Green)
3. Back Panel USB Port 0
4. Back Panel USB Port 1
5. COM Port 1 (Turquoise)
6. VGA Port (Blue)
7. Parallel Port (Printer)
8. Gigabit LAN 1
9. Gigabit LAN 2

(*See Section 2-5 for details.)

B. Front Control Panel

JF1 contains header pins for various buttons and indicators that are normally located on a control panel at the front of the chassis. These connectors are designed specifically for use with Supermicro server chassis. See Figure 2-4 for the descriptions of the various control panel buttons and LED indicators. Refer to the following section for descriptions and pin definitions.

Figure 2-4. JF1 Header Pins

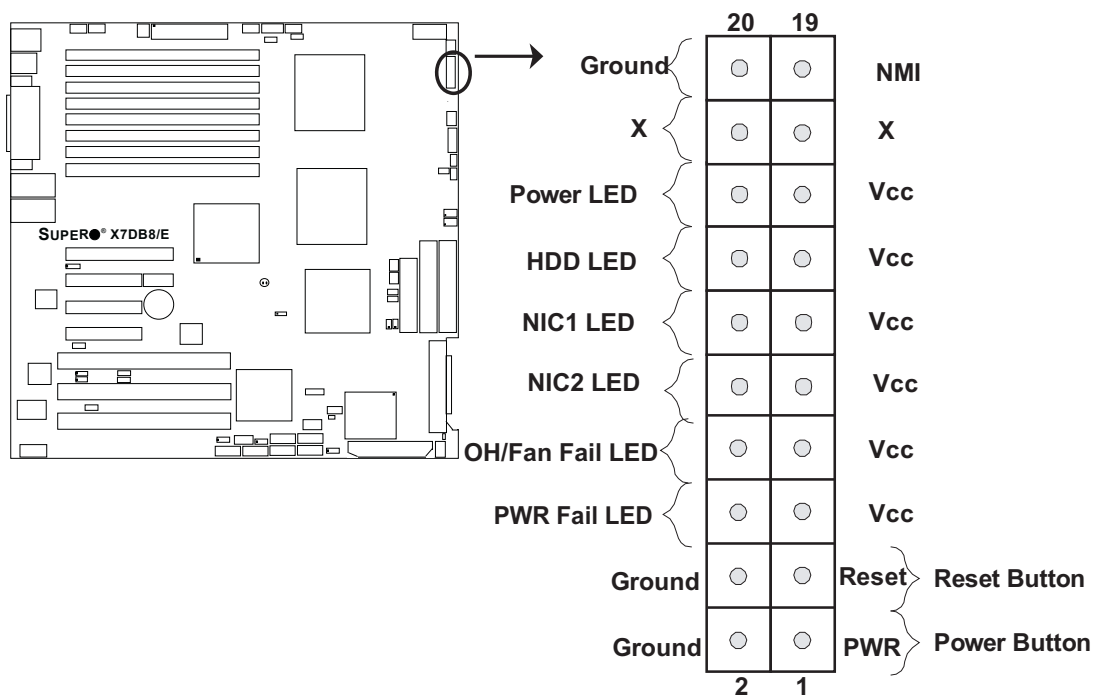

C. Front Control Panel Pin Definitions

NMI Button

The non-maskable interrupt button header is located on pins 19 and 20 of JF1. Refer to the table on the right for pin definitions.

NMI Button Pin Definitions (JF1)	
Pin#	Definition
19	Control
20	Ground

Power LED

The Power LED connection is located on pins 15 and 16 of JF1. Refer to the table on the right for pin definitions.

Power LED Pin Definitions (JF1)	
Pin#	Definition
15	+5V
16	Ground

A. NMI

B. PWR LED

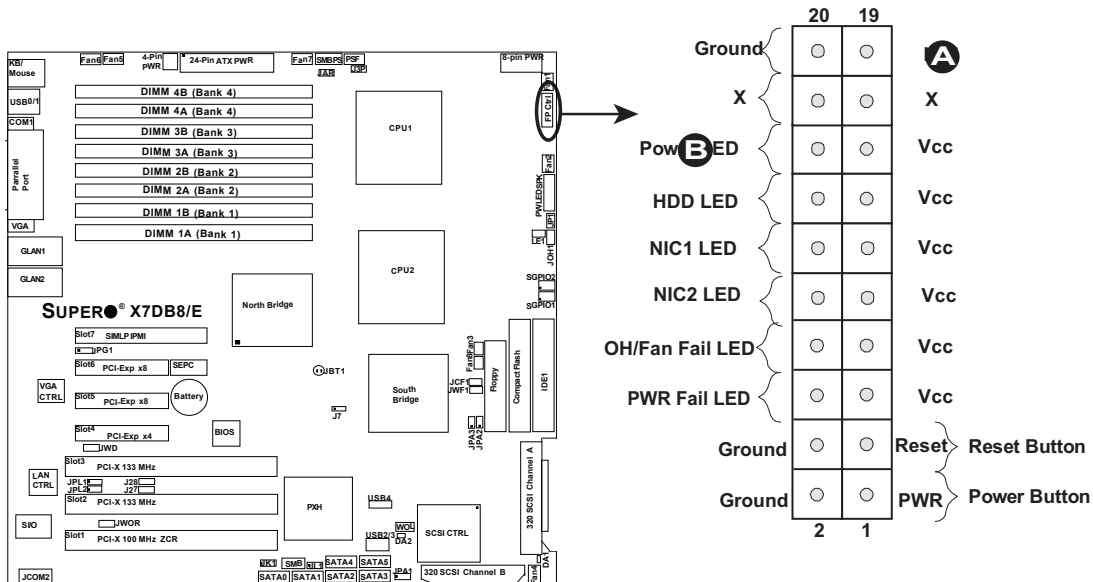

HDD LED

The HDD LED connection is located on pins 13 and 14 of JF1. Attach the hard drive LED cable here to display disk activity (for any hard drives on the system, including SAS, Serial ATA and IDE). See the table on the right for pin definitions.

HDD LED Pin Definitions (JF1)	
Pin#	Definition
13	+5V
14	HD Active

NIC1/NIC2 LED Indicators

The NIC (Network Interface Controller) LED connection for GLAN port1 is located on pins 11 and 12 of JF1 and the LED connection for GLAN Port2 is on Pins 9 and 10. Attach the NIC LED cables to display network activity. Refer to the table on the right for pin definitions.

GLAN1/2 LED Pin Definitions (JF1)	
Pin#	Definition
9/11	Vcc
10/12	Ground

- A. HDD LED
- B. NIC1 LED
- C. NIC2 LED

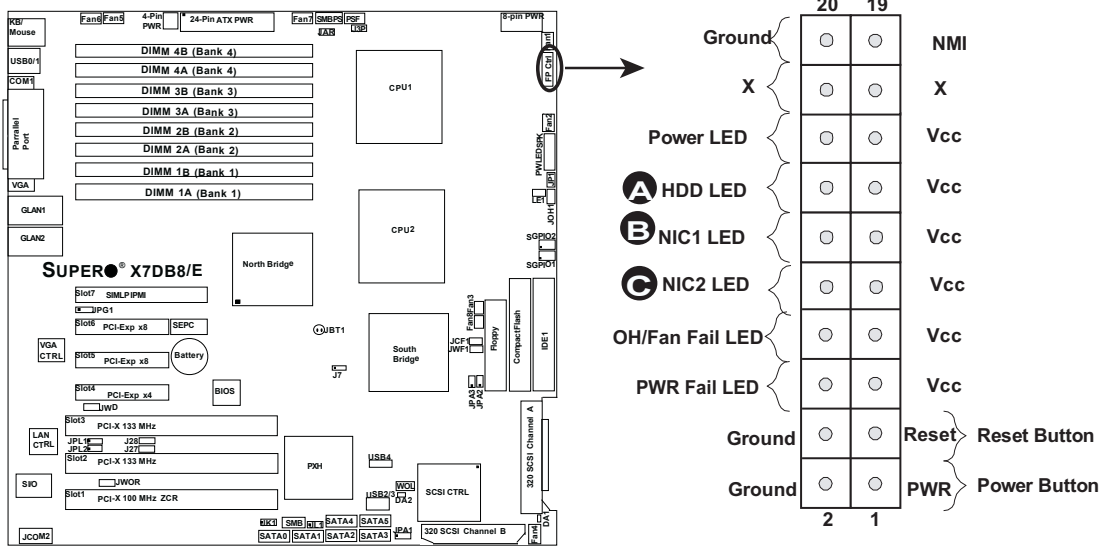

Overheat/Fan Fail LED (OH)

Connect an LED to the OH/Fan Fail connection on pins 7 and 8 of JF1 to provide advanced warning of chassis overheating or fan failure. Refer to the table on the right for pin definitions.

OH/Fan Fail LED Pin Definitions (JF1)	
Pin#	Definition
7	Vcc
8	Ground

OH/Fan Fail Indicator Status	
State	Definition
Off	Normal
On	Overheat
Flashing	Fan Fail

Power Fail LED

The Power Fail LED connection is located on pins 5 and 6 of JF1. Refer to the table on the right for pin definitions.

PWR Fail LED Pin Definitions (JF1)	
Pin#	Definition
5	Vcc
6	Ground

A. OH/Fan Fail LED

B. PWR Supply Fail

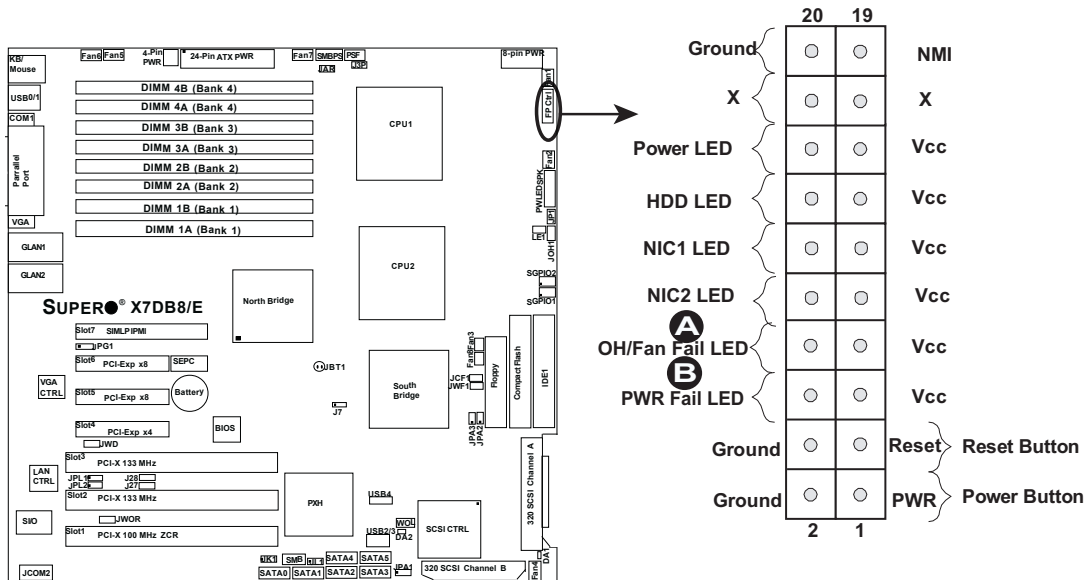

Reset Button

The Reset Button connection is located on pins 3 and 4 of JF1. Attach it to the hardware reset switch on the computer case. Refer to the table on the right for pin definitions.

Reset Button Pin Definitions (JF1)	
Pin#	Definition
3	Reset
4	Ground

Power Button

The Power Button connection is located on pins 1 and 2 of JF1. Momentarily contacting both pins will power on/off the system. This button can also be configured to function as a suspend button (with a setting in BIOS - see Chapter 4). To turn off the power when set to suspend mode, press the button for at least 4 seconds. Refer to the table on the right for pin definitions.

Power Button Pin Definitions (JF1)	
Pin#	Definition
1	Signal
2	+3V Standby

A. Reset Button

B. PWR Button

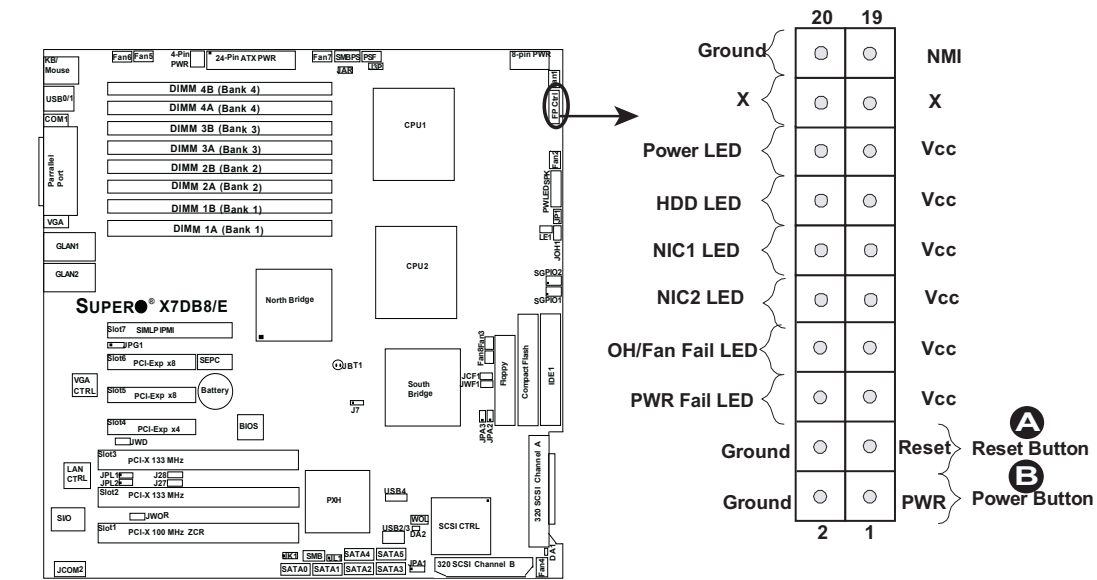

2-5 Connecting Cables

ATX Power Connector

There are a 24-pin main power supply connector(JPW1) and an 8-pin CPU PWR connector (JPW3) on the motherboard. These power connectors meet the SSI EPS 12V specification. The 4-pin 12V PWR supply is required to provide adequate power to the system. See the table on the right for pin definitions. For the 8-pin PWR (JPW3), please refer to the item listed below.

ATX Power Connector Pin Definitions			
Pin#	Definition	Pin #	Definition
13	+3.3V	1	+3.3V
14	-12V	2	+3.3V
15	COM	3	COM
16	PS_ON	4	+5V
17	COM	5	COM
18	COM	6	+5V
19	COM	7	COM
20	Res (NC)	8	PWR_OK
21	+5V	9	5VSB
22	+5V	10	+12V
23	+5V	11	+12V
24	COM	12	+3.3V

Required Connection

12V 4-pin Power Connector Pin Definitions	
Pins	Definition
1 and 2	Ground
3 and 4	+12V

Required Connection

12V 8-pin Power CPU Connector Pin Definitions	
Pins	Definition
1 through 4	Ground
5 through 8	+12V

- A. 24-pin ATX PWR
- B. 8-pin Processor PWR
- C. 4-pin PWR

Processor Power Connector

In addition to the Primary ATX power connector (above), the 12V 8-pin CPU PWR connector at JPW3 must also be connected to your power supply. See the table on the right for pin definitions.

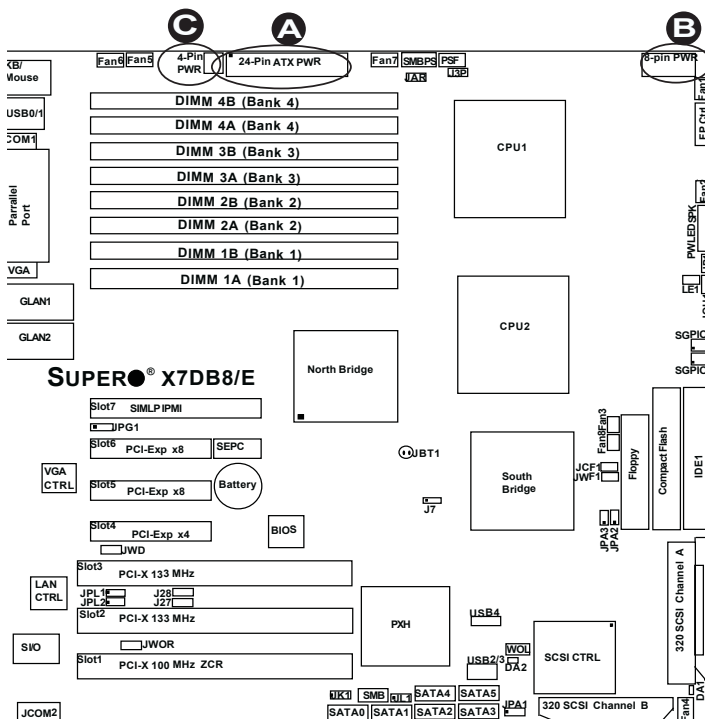

Universal Serial Bus (USB)

There are five USB 2.0 (Universal Serial Bus) ports/headers on the motherboard. Two of them are Back Panel USB ports (USB#0/1:JUSB1), and the other three are Front Panel USB headers (USB#2/3:JUSB2, USB#4:JUSB3). See the tables on the right for pin definitions.

Back Panel USB (USB#0/1)	
Pin#	Definitions
1	+5V
2	PO-
3	PO+
4	Ground
5	N/A

Front Panel USB Pin Definitions			
USB#2/4		USB#3	
Pin #	Definition	Pin #	Definition
1	+5V	1	+5V
2	PO-	2	PO-
3	PO+	3	PO+
4	Ground	4	Ground
5	Key	5	No connection

Chassis Intrusion

A Chassis Intrusion header is located at JL1 on the motherboard. Attach the appropriate cable from the chassis to inform you of a chassis intrusion when the chassis is opened.

Chassis Intrusion Pin Definitions (JL1)	
Pin#	Definition
1	Intrusion Input
2	Ground

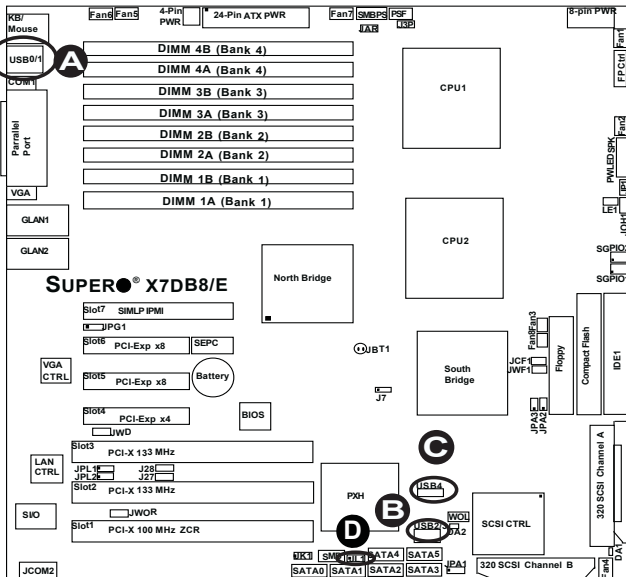

- [A. Backpanel USB 0-1](#)
- [B. Front Panel USB 2-3](#)
- [C. Front Panel USB 4](#)
- [D. Chassis Intrusion](#)

Fan Headers

The X7DB8/X7DBE has eight chassis/system fan headers (Fan1 to Fan8) and two CPU Fans (Fans 7/8). (Note: all these fans are 4-pin fans. However, Pins 1-3 of the fan headers are backward compatible with the traditional 3-pin fans.) See the table on the right for pin definitions. (*The onboard fan speeds are controlled by Thermal Management via BIOS Hardware Monitor in the Advanced Setting. Note: Default: Disabled, When using Thermal Management setting, please use all 3-pin fans or all 4-pin fans on the motherboard.)

Fan Header Pin Definitions	
Pin#	Definition
1	Ground
2	+12V
3	Tachometer
4	PWR Modulation

Keylock

The keyboard lock connection is designated JK1. Utilizing this header allows you to inhibit any actions made on the keyboard, effectively "locking" it.

Keylock Pin Definitions	
Pin#	Definition
1	Ground
2	Keylock R-N

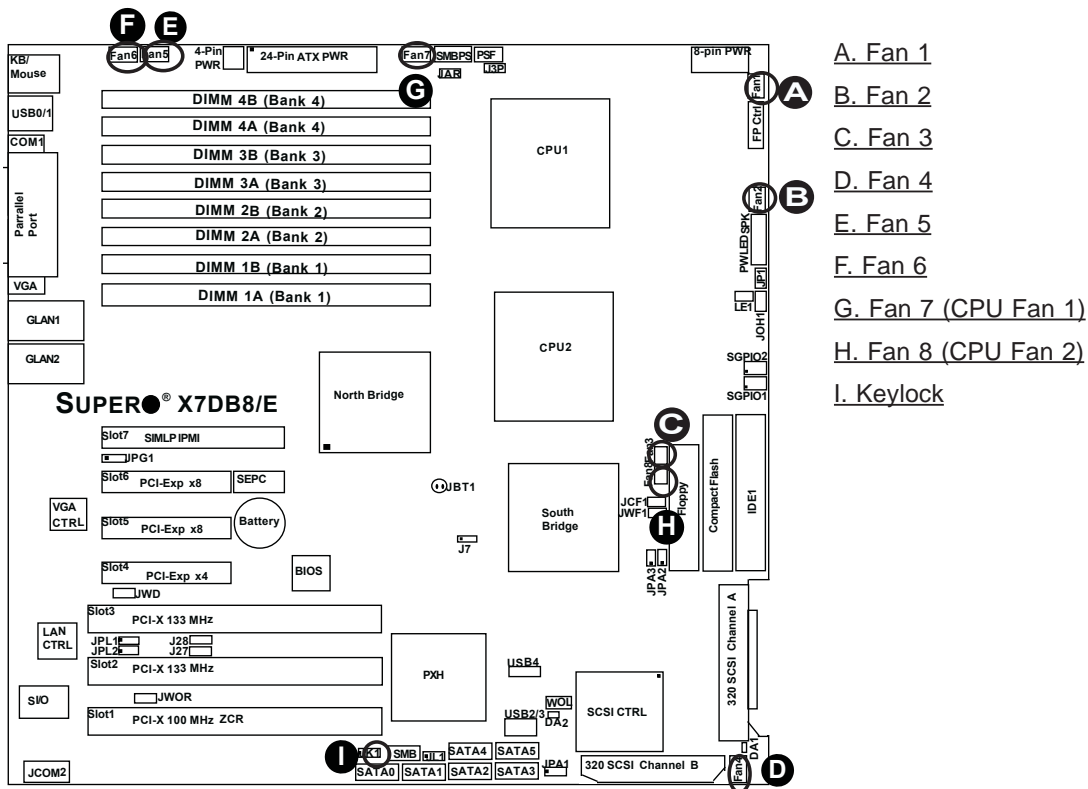

ATX PS/2 Keyboard and PS/2 Mouse Ports

The ATX PS/2 keyboard and the PS/2 mouse are located at JKM1. See the table on the right for pin definitions. (The mouse port is above the keyboard port. See the table on the right for pin definitions.)

PS/2 Keyboard and Mouse Port Pin Definitions	
Pin#	Definition
1	Data
2	NC
3	Ground
4	VCC
5	Clock
6	NC

Serial Ports

COM1 is a connector located on the IO Backpanel and COM2 is a header located at JCOM2. See the table on the right for pin definitions.

Serial Port Pin Definitions (COM1/COM2)			
Pin #	Definition	Pin #	Definition
1	CD	6	DSR
2	RD	7	RTS
3	TD	8	CTS
4	DTR	9	RI
5	Ground	10	NC

(Pin 10 is available on COM2 only. NC: No Connection.)

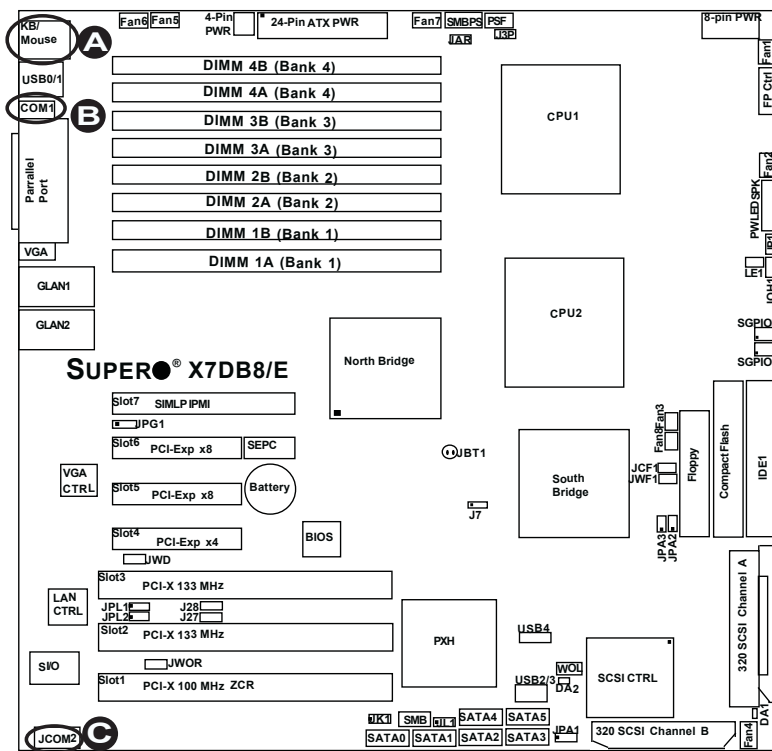

A. Keyboard/Mouse

B. COM1

C. COM2

Wake-On-Ring

The Wake-On-Ring header is designated JWOR. This function allows your computer to be "awakened" by an incoming call to the modem when the system is in the suspend state. See the table on the right for pin definitions. You must have a Wake-On-Ring card and cable to use this feature.

Wake-On-Ring Pin Definitions	
Pin#	Definition
1	Ground
2	Wake-up

Wake-On-LAN

The Wake-On-LAN header is located at JWOL on the motherboard. See the table on the right for pin definitions. (You must also have a LAN card with a Wake-On-LAN connector and cable to use this feature.)

Wake-On-LAN Pin Definitions (JWOL)	
Pin#	Definition
1	+5V Standby
2	Ground
3	Wake-up

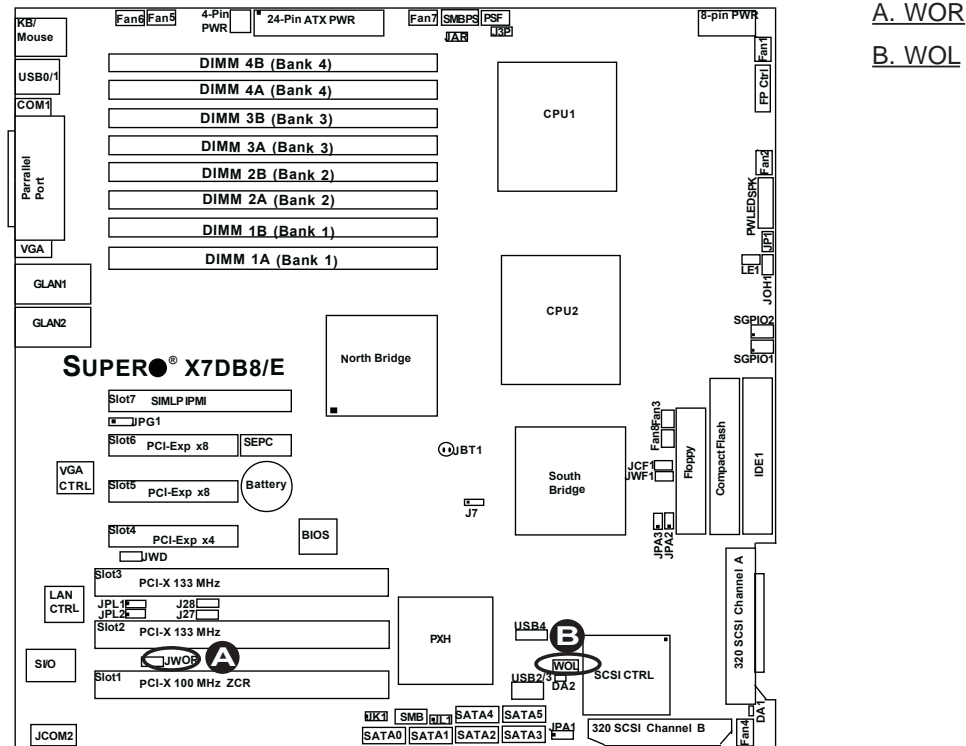

GLAN 1/2 (Giga-bit Ethernet Ports)

Two G-bit Ethernet ports are designated JLAN1 and JLAN2 on the IO backplane. This port accepts RJ45 type cables.



Power LED/Speaker

On the JD1 header, pins 1-3 are for a power LED and pins 4-7 are for the speaker. See the table on the right for speaker pin definitions. **Note:** The speaker connector pins are for use with an external speaker. If you wish to use the onboard speaker, you should close pins 6-7 with a jumper.

Speaker Connector Pin Definitions	
Pin Setting	Definition
Pins 6-7	Internal Speaker
Pins 4-7	External Speaker

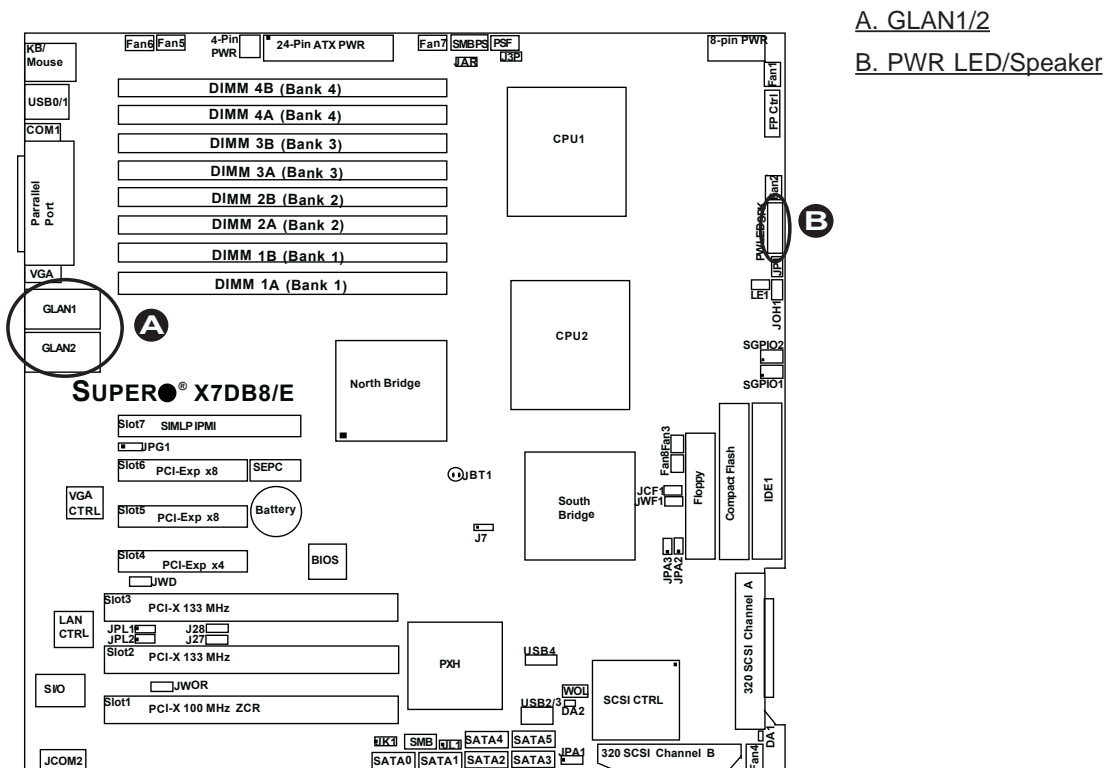

- A. GLAN1/2
- B. PWR LED/Speaker

Power Fault (PWR Supply Failure)

Connect a cable from your power supply to the Power Fail (PSF) header to provide warnings of power supply failure. This warning signal is passed through the PWR_LED pin to indicate of a power failure on the chassis. See the table on the right for pin definitions.

PWR Supply Fail LED Pin Definitions	
Pin#	Definition
1	PWR 1: Fail
2	PWR 2: Fail
3	PWR 3: Fail
4	Signal: Alarm Reset

Note: This feature is only available when using Supermicro redundant power supplies.

Alarm Reset

If three power supplies are installed and Alarm Reset (JAR) is enabled, the system will notify you when any of the three power modules fails. Connect JAR to a micro-switch to enable you to turn off the alarm that is activated when a power module fails. See the table on the right for pin definitions.

Alarm Reset Pin Definitions	
Pin Setting	Definition
Pin 1	Ground
Pin 2	+5V

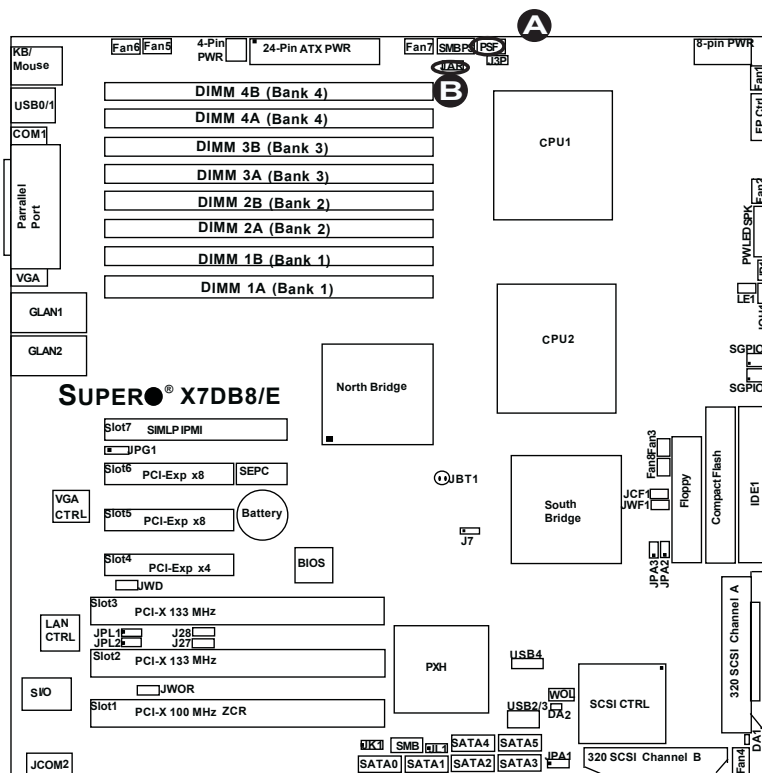

A. Power Fault
B. Alarm Reset

Overheat LED/Fan Fail (JOH1)

The JOH1 header is used to connect an LED to provide warning of chassis overheating. This LED will blink to indicate a fan failure. Refer to the table on right for pin definitions.

Overheat LED Pin Definitions	
Pin#	Definition
1	5vDC
2	OH Active

OH/Fan Fail LED	
State	Message
Solid	Overheat
Blinking	Fan Fail

SMB

A System Management Bus header is located at J18. Connect the appropriate cable here to utilize SMB on your system.

SMB Header Pin Definitions	
Pin#	Definition
1	Data
2	Ground
3	Clock
4	No Connection

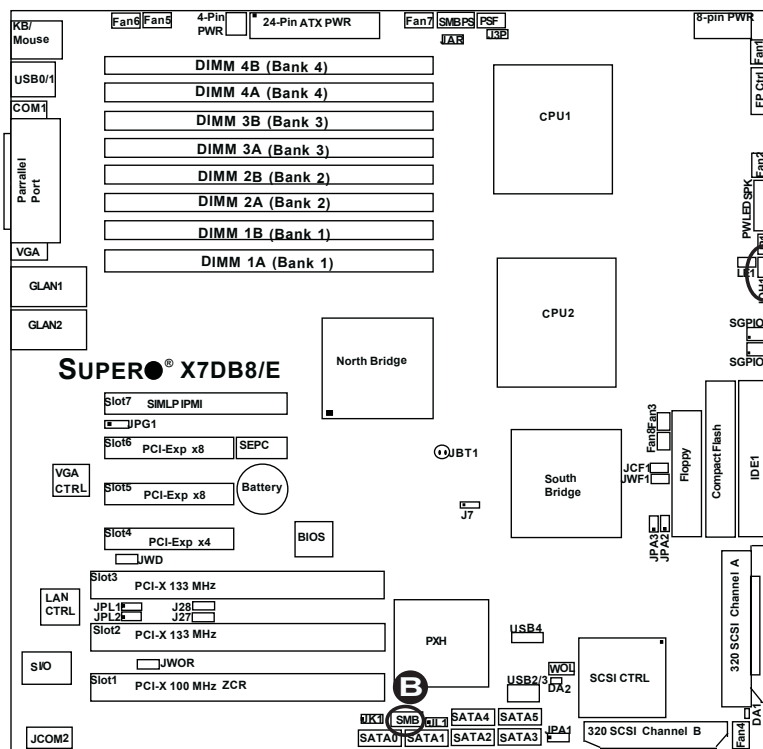

A. OH/Fan Fail LED

B. SMB

Power SMB (I²C) Connector

Power SMB (I²C) Connector (J17) monitors the status of PWR Supply, fan and system temperature status. See the table on the right for pin definitions.

PWR SMB Pin Definitions	
Pin#	Definition
1	Clock
2	Data
3	PWR Fail
4	Ground
5	+3.3V

VGA Connector

A VGA connector (JG1) is located next to the COM1 port on the IO backplane. Refer to the board layout below for the location.

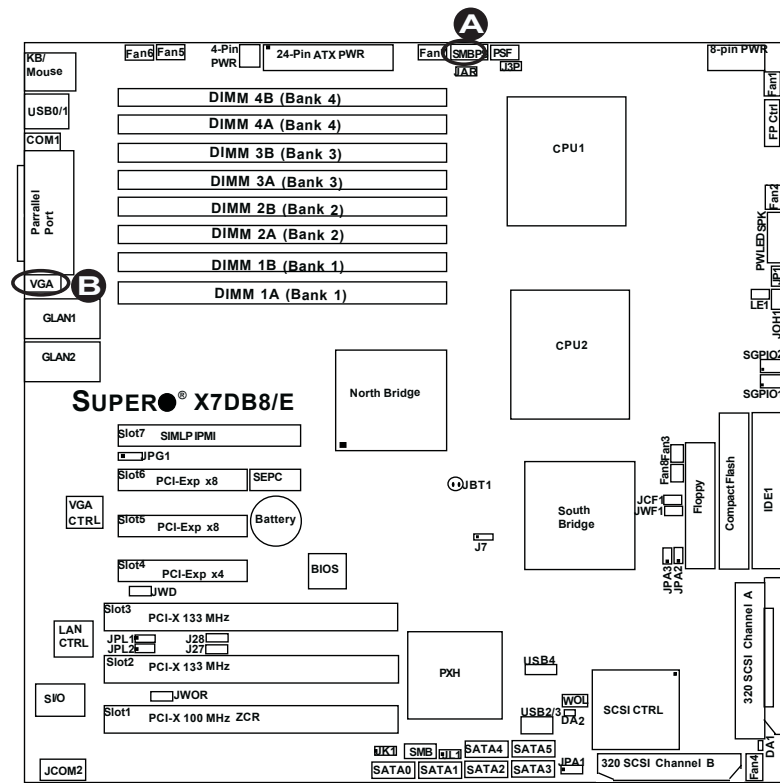

A. PWR SMB

B. VGA

Compact Flash Card PWR Connector

A Compact Flash Card Power Connector is located at JWF1. For the Compact Flash Card or the Compact Flash Jumper (JCF1) to work properly, you will need to connect the Compact Flash Card power cable to JWF1 first. Refer to the board layout below for the location.

Compact Flash Card PWR Connector	
Jumper	Definition
On	Compact Flash Power On
Off	Compact Flash Power Off

SGPIO Headers

There are two SGPIO (Serial General Purpose Input/Output) headers (J29, J30) located on the motherboard. These headers support serial link interfaces for the onboard SATA and SAS connectors. See the table on the right for pin definitions. Refer to the board layout below for the location.

SGPIO Pin Definitions			
Pin#	Definition	Pin	Definition
1	*NC	2	*NC
3	Ground	4	Data
5	Load	6	Ground
7	*NC	8	*NC

Note: NC= No Connections

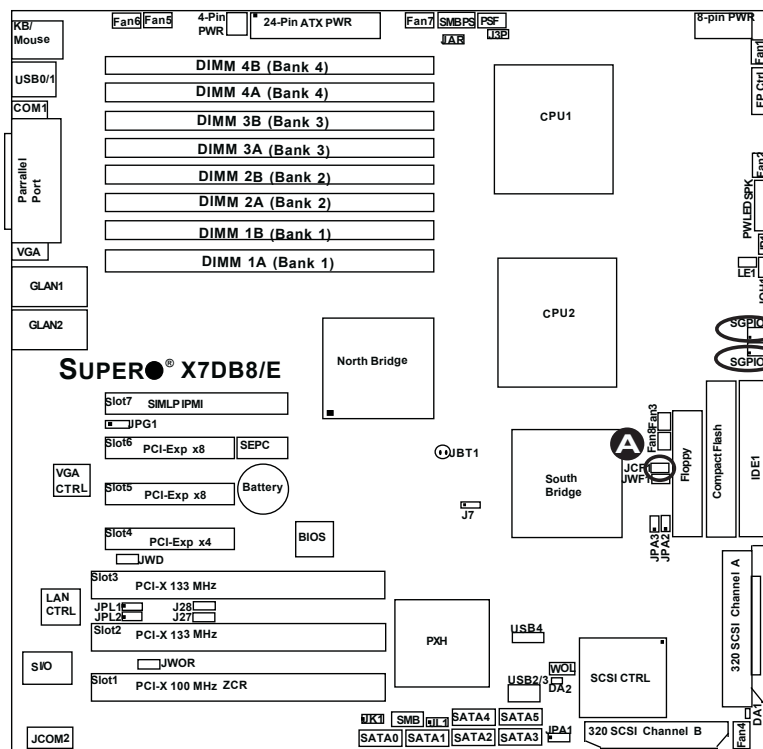

- A. Compact Flash PWR
- B. SGPIO1
- C. SGPIO2

2-6 Jumper Settings

Explanation of Jumpers

To modify the operation of the motherboard, jumpers can be used to choose between optional settings. Jumpers create shorts between two pins to change the function of the connector. Pin 1 is identified with a square solder pad on the printed circuit board. See the motherboard layout pages for jumper locations.

Note: On two pin jumpers, "Closed" means the jumper is on and "Open" means the jumper is off the pins.

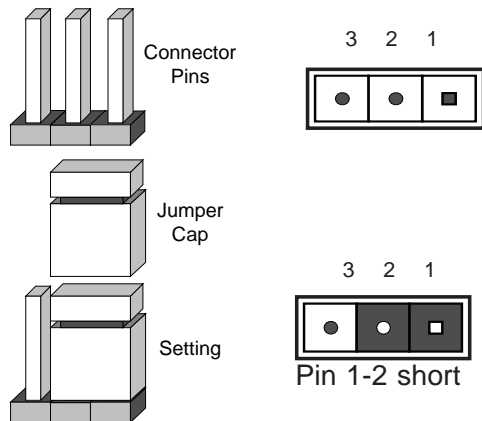

GLAN Enable/Disable

JPL1/JPL2 enable or disable GLAN Port1/GLAN Port2 on the motherboard. See the table on the right for jumper settings. The default setting is enabled.

GLAN Enable Jumper Settings	
Pin#	Definition
1-2	Enabled (*default)
2-3	Disabled

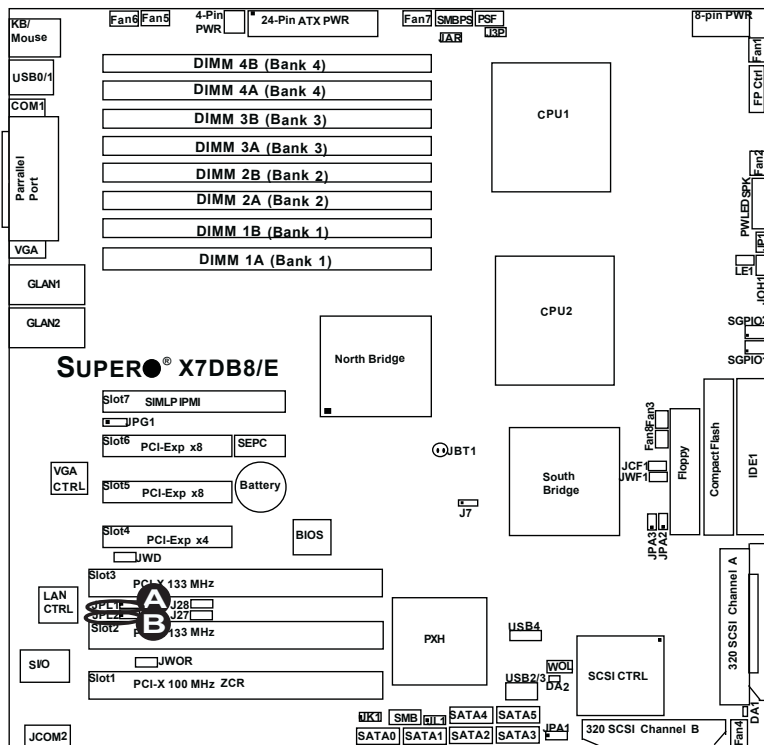

- A. GLAN Port1 Enable
- B. GLAN Port2 Enable

CMOS Clear

JBT1 is used to clear CMOS. Instead of pins, this "jumper" consists of contact pads to prevent the accidental clearing of CMOS. To clear CMOS, use a metal object such as a small screwdriver to touch both pads at the same time to short the connection. Always remove the AC power cord from the system before clearing CMOS.

Note: For an ATX power supply, you must completely shut down the system, remove the AC power cord and then short JBT1 to clear CMOS.



Watch Dog Enable/Disable

Watch Dog is a system monitor that can reboot the system when a software application hangs. Close Pins 1-2 to reset the system if an application hangs. Close Pins 2-3 to generate a non-maskable interrupt signal for the application that is hung up. See the table on the right for jumper settings. Watch Dog must also be enabled in the BIOS.

Watch Dog Jumper Settings (JWD)	
Jumper Setting	Definition
Pins 1-2	Reset (*default)
Pins 2-3	NMI
Open	Disabled

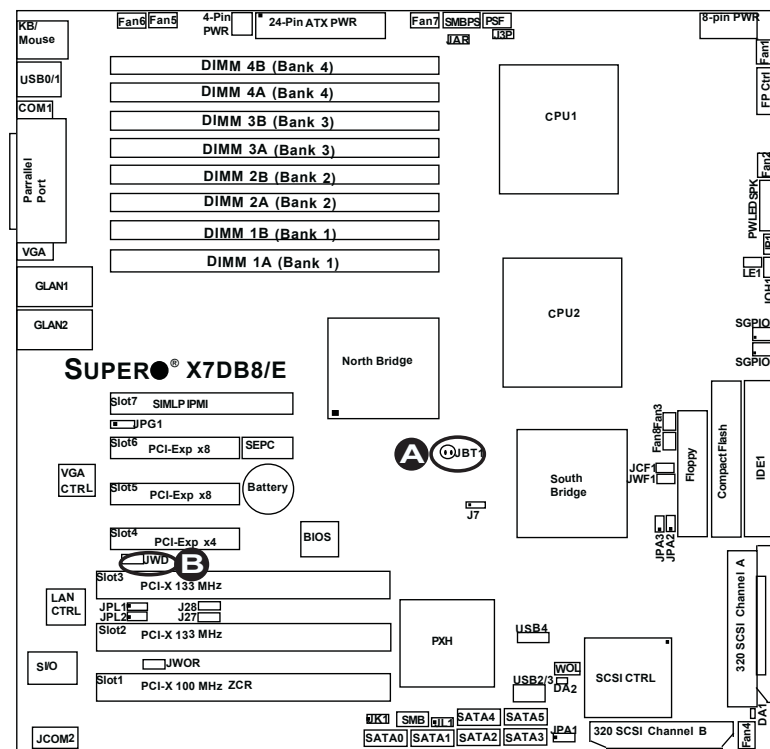

- A. Clear CMOS
- B. Watch Dog Enable

SCSI Controller Enable/Disable

Jumper JPA1 is used to enable or disable the LSI SCSI controller. The default setting is on pins 1-2 to enable SCSI. See the table on the right for jumper settings.

VGA Enable/Disable Jumper Settings (JPA1)	
Jumper Setting	Definition
Pins 1-2	Enabled
Pins 2-3	Disabled

SCSI Termination Enable/Disable

Jumpers JPA2/JPA3 are used to enable or disable termination for SCSI Channel A (JPA2) and Channel B (JPA3) connectors. The default setting is open to enable termination. See the table on the right for jumper settings.

SCSI Term. Enable/Disable Jumper Settings	
Jumper Setting	Definition
Open	Enabled
Closed	Disabled

Note: In order for the SCSI drives to function properly, please do not change the default setting (enabled) set by the manufacturer.

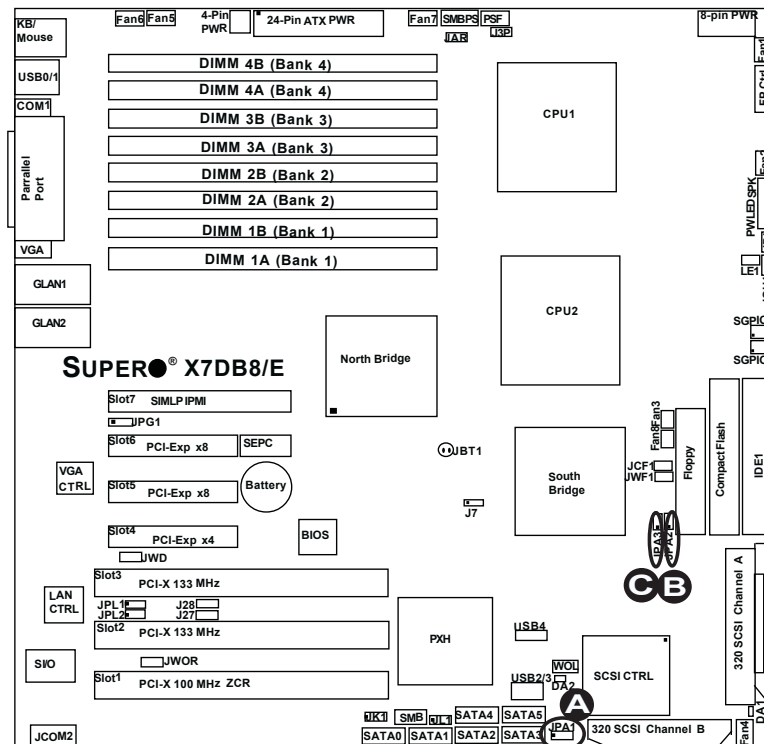

- A. SCSI Enable
- B. SCSI Channel A Termination Enable
- C. SCSI Channel B Termination Enable

3rd PWR Supply PWR Fault Detect (J3P)

The system can notify you in the event of a power supply failure. This feature available when three power supply units are installed in the chassis with one acting as a backup. If you only have one or two power supply units installed, you should disable this (the default setting) with J3P to prevent false alarms.

3rd PWR Supply PWR Fault Jumper Settings	
Jumper Setting	Definition
Closed	Enabled
Open	Disabled (*Default)

VGA Enable/Disable

JPG1 allows you to enable or disable the VGA port. The default position is on pins 1 and 2 to enable VGA. See the table on the right for jumper settings.

SCSI Enable/Disable Jumper Settings	
Both Jumpers	Definition
Pins 1-2	Enabled
Pins 2-3	Disabled

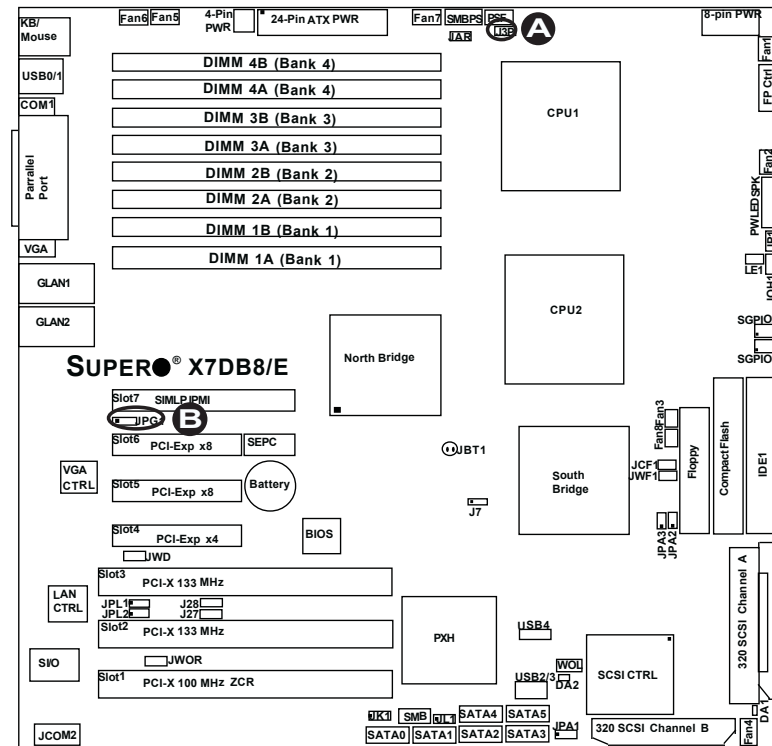

- A. 3rd PWR Fail
- B. VGA Enabled

Compact Flash Master/Slave Select

A Compact Flash Master (Primary)/Slave (Secondary) Select Jumper is located at JCF1. Close this jumper to enable Compact Flash Card. For the Compact Flash Card or the Compact Flash Jumper (JCF1) to work properly, you will need to connect the Compact Flash Card power cable to JWF1 first. Refer to the board layout below for the location.

Compact Flash Card Master/ Slave Select	
Jumper	Definition
Open	Slave (Secondary)
Closed	Master (Primary)

I²C Bus to PCI-X/PCI-Exp. Slots

Jumpers J27, J28 allow you to connect the System Management Bus (I²C) to PCI-X/PCI-E slots. The default setting is "Open" to disable the connection. See the table on the right for jumper settings.

I ² C to PCI-S/PCI/Exp Jumper Settings	
Jumper Setting	Definition
Closed	Enabled
Open	Disabled (*Default)

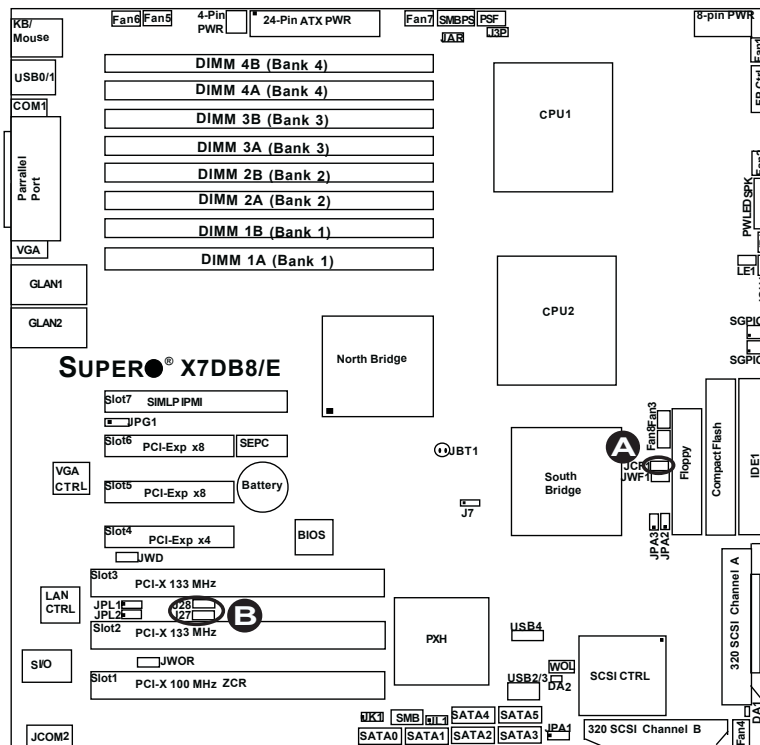

- A. Compact Flash Master/ Slave Select
- B. SMBus to PCI slots

2-7 Onboard Indicators

GLAN LEDs

There are two GLAN ports on the motherboard. Each Gigabit Ethernet LAN port has two LEDs. The yellow LED indicates activity, while the link LED may be green, amber or off to indicate the speed of the connection. See the tables at right for more information.

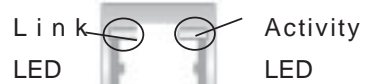

(*Rear View: when viewing it from the rear side of the chassis)

GLAN Activity Indicator		
Color	Status	Definition
Yellow	Flashing	Active

GLAN Link Indicator	
LED Color	Definition
Off	No Connection or 10 Mbps
Green	100 Mbps
Amber	1 Gbps

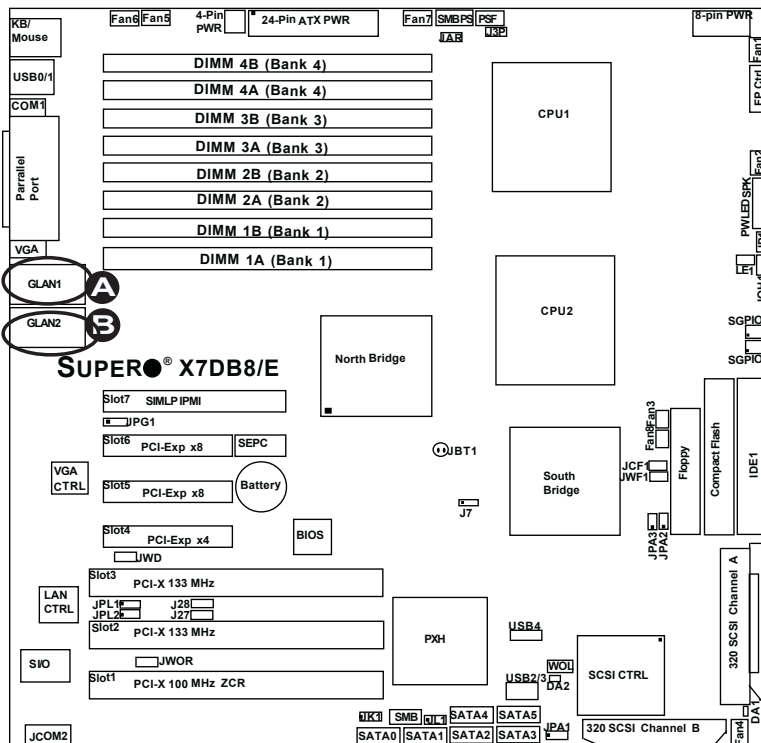

A. GLAN Port1 LEDs

B. GLAN Port2 LEDs

Onboard SCSI Activity LED Indicators (*X7DB8 only)

There are two Onboard SCSI Activity LED indicators on the X7DB8. DA1 indicates the activity status of SCSI Channel A, and DA2 indicates the activity status of SCSI Channel B.

Onboard Power LED

There is an Onboard Power LED located on the motherboard. When this LED is lit, the system is on. Be sure to turn off the system and unplug the power cord before removing or installing components. See the layout below for the LED location.

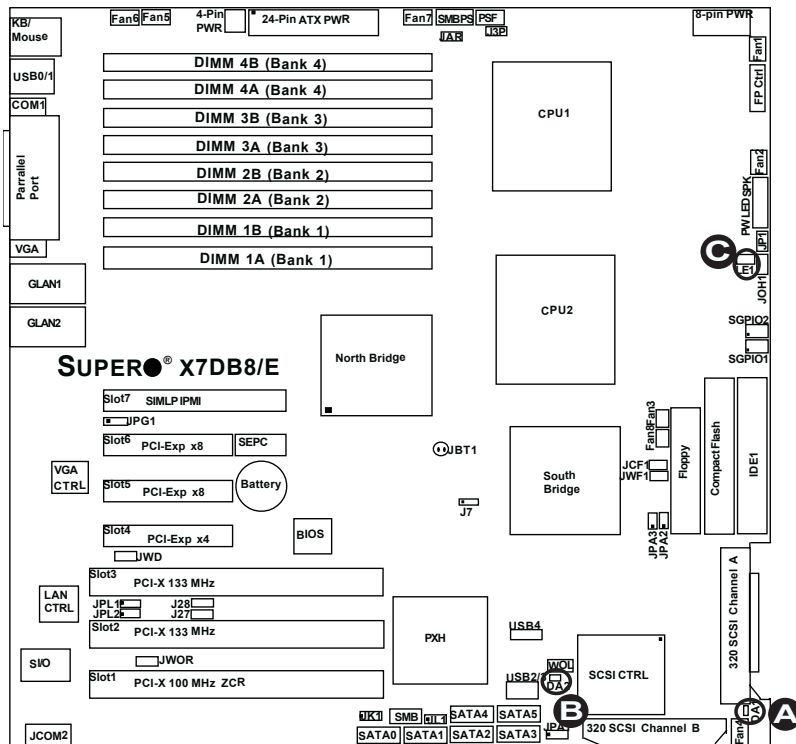

A. SCSI Channel A Activity LED

B. SCSI Channel B Activity LED

C. Onboard PWR LED

2-8 Parallel Port, Floppy Drive, Hard Disk Drive, SIMLP IPMI and SCSI Connections

Note the following when connecting the floppy and hard disk drive cables:

- The floppy disk drive cable has seven twisted wires.
- A red mark on a wire typically designates the location of pin 1.
- A single floppy disk drive ribbon cable has 34 wires and two connectors to provide for two floppy disk drives. The connector with twisted wires always connects to drive A, and the connector that does not have twisted wires always connects to drive B.

Parallel (Printer) Port Connector

The parallel (printer) port is located on the IO Back Panel. See the table on the right for pin definitions.

Parallel (Printer) Port Connector Pin Definitions			
Pin#	Definition	Pin #	Definition
1	Strobe-	2	Auto Feed-
3	Data Bit 0	4	Error-
5	Data Bit 1	6	Init-
7	Data Bit 2	8	SLCT IN-
9	Data Bit 3	10	GND
11	Data Bit 4	12	GND
13	Data Bit 5	14	GND
15	Data Bit 6	16	GND
17	Data Bit 7	18	GND
19	ACK	20	GND
21	BUSY	22	Write Data
23	PE	24	Write Gate
25	SLCT	26	NC

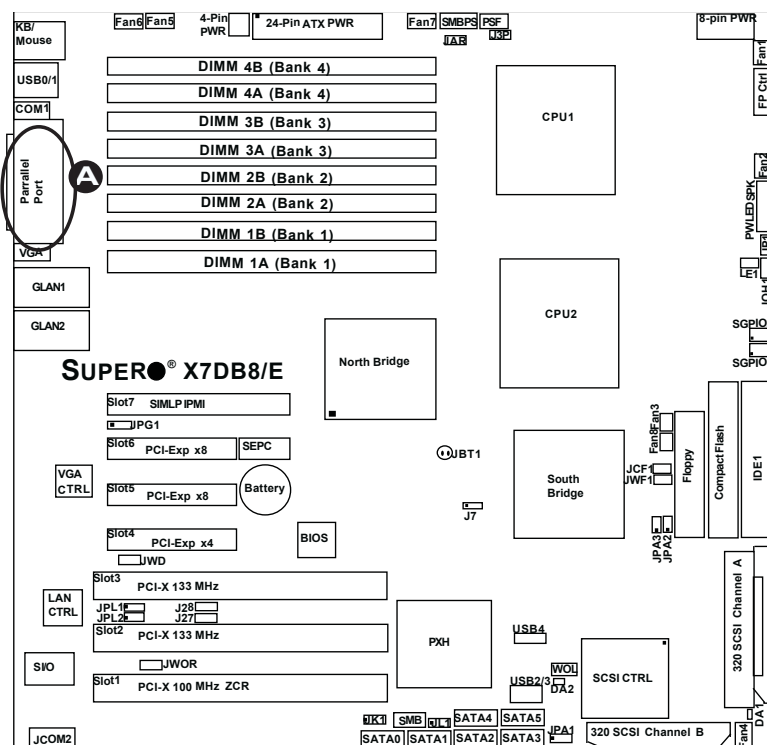

A. Parallel Port

Floppy Connector

The floppy connector is located next to the compact flash card slot. See the table below for pin definitions.

Floppy Drive Connector Pin Definitions (Floppy)			
Pin#	Definition	Pin #	Definition
1	Ground	2	FDHDIN
3	Ground	4	Reserved
5	Key	6	FDEDIN
7	Ground	8	Index
9	Ground	10	Motor Enable
11	Ground	12	Drive Select B
13	Ground	14	Drive Select B
15	Ground	16	Motor Enable
17	Ground	18	DIR
19	Ground	20	STEP
21	Ground	22	Write Data
23	Ground	24	Write Gate
25	Ground	26	Track 00
27	Ground	28	Write Protect
29	Ground	30	Read Data
31	Ground	32	Side 1 Select
33	Ground	34	Diskette

SIMLP IPMI Slot

There is a SIM Low Profile IPMI Slot on the motherboard. Refer to the layout below for the IPMI Slot location.

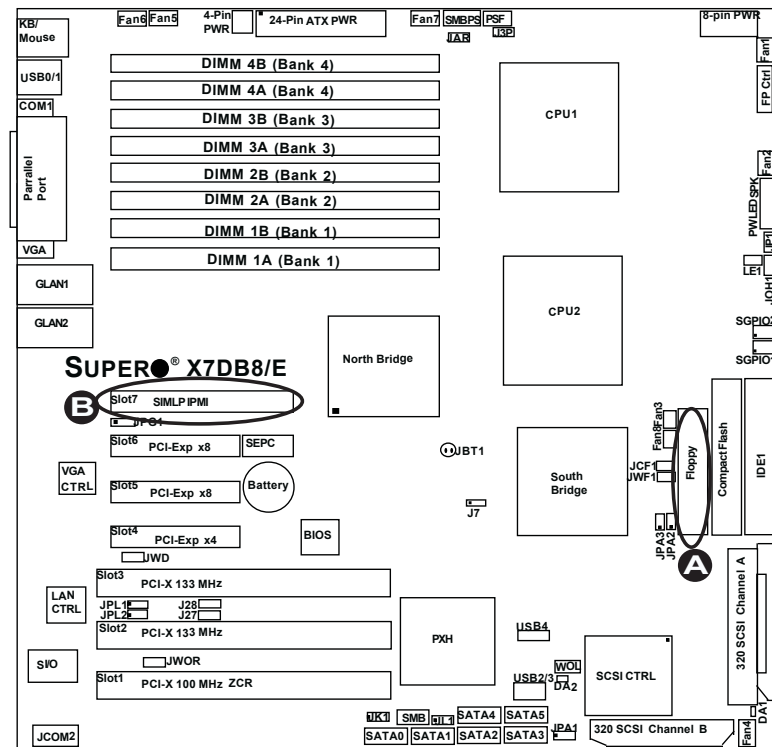

A. Floppy

B. SIMLP IPMI

IDE Connectors

There are two IDE Connectors (JIDE1: Blue, JIDE2: White) on the motherboard. The blue IDE connector (JIDE1) is designated as the Primary IDE Drive. The white IDE connector (JIDE2) is designated as the Secondary IDE Drive, reserved for Compact Flash Card use only. (See the note below.) See the table on the right for pin definitions.

Note: JIDE2 (the white slot) is reserved for Compact Flash Card only. Do not use it for other devices. If JIDE2 is populated with a Compact Flash Card, JIDE1 (the blue slot) will be available for one device only. For the Compact Flash Card to work properly, you will need to connect a power cable to JWF1 first.

IDE Drive Connectors Pin Definitions			
Pin#	Definition	Pin #	Definition
1	Reset IDE	2	Ground
3	Host Data 7	4	Host Data 8
5	Host Data 6	6	Host Data 9
7	Host Data 5	8	Host Data 10
9	Host Data 4	10	Host Data 11
11	Host Data 3	12	Host Data 12
13	Host Data 2	14	Host Data 13
15	Host Data 1	16	Host Data 14
17	Host Data 0	18	Host Data 15
19	Ground	20	Key
21	DRQ3	22	Ground
23	I/O Write	24	Ground
25	I/O Read	26	Ground
27	IOCHRDY	28	BALE
29	DACK3	30	Ground
31	IRQ14	32	IOCS16
33	Addr1	34	Ground
35	Addr0	36	Addr2
37	Chip Select 0	38	Chip Select 1
39	Activity	40	Ground

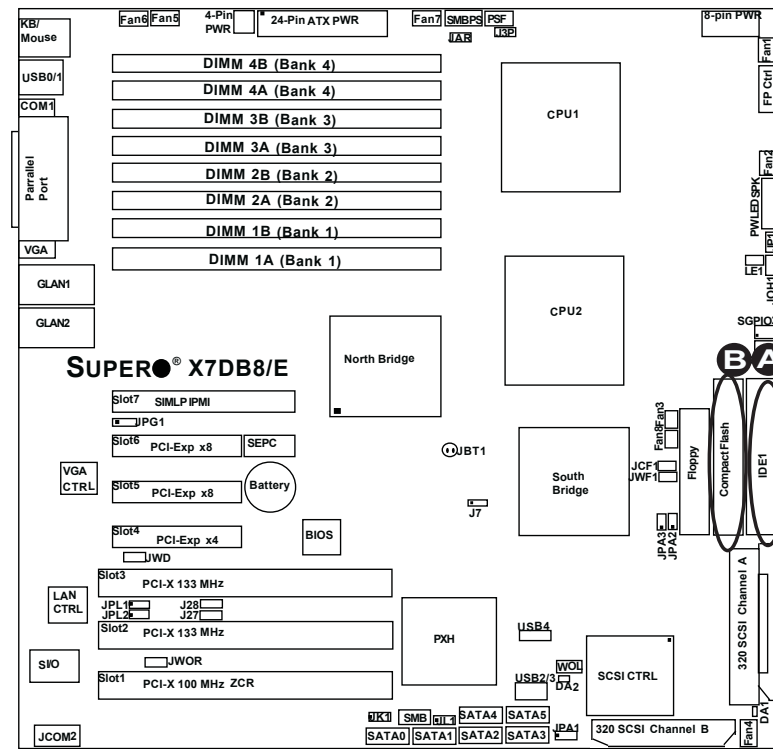

- A. IDE#1
- B. Compact Flash Card

Ultra 320 SCSI Connectors (*X7DB8 only)

There are two SCSI connectors on the motherboard. SCSI Channel A is located at JA1, and SCSI Channel B is located at A2. Refer to the table below for the pin definitions of the Ultra 320 SCSI connectors located at JA1 and JA2.

Ultra320 SCSI Drive Connector Pin Definitions			
Pin#	Definition	Pin #	Definition
1	+DB (12)	35	-DB (12)
2	+DB (13)	36	-DB (13)
3	+DB (14)	37	-DB (14)
4	+DB (15)	38	-DB (15)
5	+DB (P1)	39	-DB (P1)
6	+DB (0)	40	-DB (0)
7	+DB (1)	41	-DB (1)
8	+DB (2)	42	-DB (2)
9	+DB (3)	43	-DB (3)
10	+DB (4)	44	-DB (4)
11	+DB (5)	45	-DB (5)
12	+DB (6)	46	-DB (6)
13	+DB (7)	47	-DB (7)
14	+DB (P)	48	-DB (P)
15	Ground	49	Ground
16	DIFFSENS	50	Ground
17	TERMPWR	51	TERMPWR
18	TERMPWR	52	TERMPWR
19	Reserved	53	Reserved
20	Ground	54	Ground
21	+ATN	55	-ATN
22	Ground	56	Ground
23	+BSY	57	-BSY
24	+ACK	58	-ACK
25	+RST	59	-RST
26	+MSG	60	-MSG
27	+SEL	61	-SEL
28	+C/D	62	-C/D
29	+REQ	63	-REQ
30	+I/O	64	-I/O
31	+DB (8)	65	-DB (8)
32	+DB (9)	66	-DB (9)
33	+DB (10)	67	-DB (10)
34	+DB (11)	68	-DB (11)

A. SCSI Channel A

B. SCSI Channel B

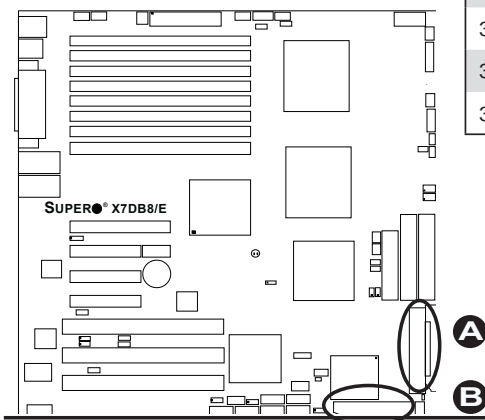

Chapter 3

Troubleshooting

3-1 Troubleshooting Procedures

Use the following procedures to troubleshoot your system. If you have followed all of the procedures below and still need assistance, refer to the 'Technical Support Procedures' and/or 'Returning Merchandise for Service' section(s) in this chapter.

Note: Always disconnect the power cord before adding, changing or installing any hardware components.

Before Power On

1. Make sure that there are no short circuits between the motherboard and chassis.
2. Disconnect all ribbon/wire cables from the motherboard, including those for the keyboard and mouse.
3. Remove all add-on cards.
4. Install one CPU (making sure it is fully seated) and connect the chassis speaker and the power LED to the motherboard. (Check all jumper settings as well.)

No Power

1. Make sure that there are no short circuits between the motherboard and the chassis.
2. Make sure that all jumpers are set to their default positions.
3. Check to make sure that the 115V/230V switch on the power supply is properly set.
4. Turn the power switch on and off to test the system.
5. The battery on your motherboard may be old. Check to verify that it still supplies ~3VDC. If it does not, replace it with a new one.

No Video

1. If the power is on but you have no video, remove all the add-on cards and cables.
2. Use the speaker to determine if any beep codes exist. Refer to the Appendix for details on beep codes.

Losing the System's Setup Configuration

1. Make sure that you are using a high quality power supply. A poor quality power supply may cause the system to lose the CMOS setup information. Refer to Section 1-6 for details on recommended power supplies.

2. The battery on your motherboard may be old. Check to verify that it still supplies ~3VDC. If it does not, replace it with a new one.
3. If the above steps do not fix the Setup Configuration problem, contact your vendor for repairs.

NOTE

If you are a system integrator, VAR or OEM, a POST diagnostics card is recommended. For I/O port 80h codes, refer to App. B.

Memory Errors

1. Make sure that the DIMM modules are properly and fully installed.
2. Check if different speeds of DIMMs have been installed and verify that the BIOS setup is configured for the fastest speed of RAM used. It is recommended to use the same RAM speed for all DIMMs in the system.
3. Make sure that you are using the correct type of DDR2 Fully Buffered (FBD) ECC 533/667 SDRAM (*recommended by the manufacturer.)
4. Check for bad DIMM modules or slots by swapping a single module between four slots and noting the results.
5. Make sure that all memory modules are fully seated in their slots. As an interleaved memory scheme is used, you must install two modules at a time, beginning with Bank 1, then Bank 2, and so on (see Section 2-3).
6. Check the position of the 115V/230V switch on the power supply.

3-2 Technical Support Procedures

Before contacting Technical Support, please take the following steps. Also, note that as a motherboard manufacturer, Supermicro does not sell directly to end-users, so it is best to first check with your distributor or reseller for troubleshooting services. They should know of any possible problem(s) with the specific system configuration that was sold to you.

1. Please go through the 'Troubleshooting Procedures' and 'Frequently Asked Question' (FAQ) sections in this chapter or see the FAQs on our web site (<http://www.supermicro.com/support/faqs/>) before contacting Technical Support.
2. BIOS upgrades can be downloaded from our web site at (<http://www.supermicro.com/support/bios/>)

Note: Not all BIOS can be flashed; it depends on the modifications to the boot block code.

3. If you still cannot resolve the problem, include the following information when contacting Supermicro for technical support:
-

- Motherboard model and PCB revision number
- BIOS release date/version (this can be seen on the initial display when your system first boots up)
- System configuration

An example of a Technical Support form is on our web site at (<http://www.supermicro.com/support/contact.cfm>).

4. Distributors: For immediate assistance, please have your account number ready when placing a call to our technical support department. We can be reached by e-mail at support@supermicro.com or by fax at: (408) 503-8000,option 2.

3-3 Frequently Asked Questions

Question: What are the various types of memory that my motherboard can support?

Answer: The X7DB8/X7DBE has eight 240-pin DIMM slots that support DDR2 FDB ECC 533/667 SDRAM modules. It is strongly recommended that you do not mix memory modules of different speeds and sizes. (See Chapter 2 for detailed Information.)

Question: How do I update my BIOS?

Answer: It is recommended that you do not upgrade your BIOS if you are not experiencing any problems with your system. Updated BIOS files are located on our web site at <http://www.supermicro.com/support/bios/>. Please check our BIOS warning message and the information on how to update your BIOS on our web site. Select your motherboard model and download the BIOS file to your computer. Also, check the current BIOS revision and make sure that it is newer than your BIOS before downloading. You can choose from the zip file and the .exe file. If you choose the zip BIOS file, please unzip the BIOS file onto a bootable device or a USB pen. Run the batch file using the format flash.bat filename.rom from your bootable device or USB pen to flash the BIOS. Then, your system will automatically reboot. If you choose the .exe file, please run the .exe file under Windows to create the BIOS flash floppy disk. Insert the floppy disk into the system you wish to flash the BIOS. Then, bootup the system to the floppy disk. The BIOS utility will automatically flash the BIOS without any prompts. Please note that this process may take a few minutes to complete. Do not be concerned if the screen is paused for a few minutes.



(Warning: Do not shut down or reset the system while updating BIOS to prevent possible system boot failure!)

Question: What's on the CD that came with my motherboard?

Answer: The supplied compact disc has quite a few drivers and programs that will greatly enhance your system. We recommend that you review the CD and install the applications you need. Applications on the CD include chipset drivers for Windows and security and audio drivers.

3-4 Returning Merchandise for Service

A receipt or copy of your invoice marked with the date of purchase is required before any warranty service will be rendered. You can obtain service by calling your vendor for a Returned Merchandise Authorization (RMA) number. When returning to the manufacturer, the RMA number should be prominently displayed on the outside of the shipping carton, and mailed prepaid or hand-carried. Shipping and handling charges will be applied for all orders that must be mailed when service is complete.

For faster service, RMA authorizations may be requested online (<http://www.supermicro.com/support/rma>).

This warranty only covers normal consumer use and does not cover damages incurred in shipping or from failure due to the alternation, misuse, abuse or improper maintenance of products.

During the warranty period, contact your distributor first for any product problems.

Chapter 4

BIOS

4-1 Introduction

This chapter describes the Phoenix BIOS™ Setup utility for the X7DB8/X7DBE. The Phoenix ROM BIOS is stored in a flash chip and can be easily upgraded using a floppy disk-based program.

Note: Due to periodic changes to the BIOS, some settings may have been added or deleted and might not yet be recorded in this manual. Please refer to the Manual Download area of the Supermicro web site <<http://www.supermicro.com>> for any changes to the BIOS that may not be reflected in this manual.

System BIOS

The BIOS is the Basic Input Output System used in all IBM® PC, XT™, AT®, and PS/2® compatible computers. The Phoenix BIOS stores the system parameters, types of disk drives, video displays, etc. in the CMOS. The CMOS memory requires very little electrical power. When the computer is turned off, a backup battery provides power to the CMOS Logic, enabling it to retain system parameters. When the computer is powered on, the computer is configured with the values stored in the CMOS Logic by the system BIOS, which gains control at boot up.

How To Change the Configuration Data

The CMOS information that determines the system parameters may be changed by entering the BIOS Setup utility. This Setup utility can be accessed by pressing the <Delete> key at the appropriate time during system boot. (See below.)

Starting the Setup Utility

Normally, the only visible POST (Power On Self Test) routine is the memory test. As the memory is being tested, press the <Delete> key to enter the main menu of the BIOS Setup utility. From the main menu, you can access the other setup screens, such as the Security and Power menus. Beginning with Section 4-3, detailed descriptions are given for each parameter setting in the Setup utility.



Warning: Do not shut down or reset the system while updating BIOS to prevent possible boot failure.

4-2 Running Setup

**Default settings are in bold text unless otherwise noted.*

The BIOS setup options described in this section are selected by choosing the appropriate text from the main BIOS Setup screen. All displayed text is described in this section, although the screen display is often all you need to understand how to set the options (see the next page).

When you first power on the computer, the Phoenix BIOS™ is immediately activated.

While the BIOS is in control, the Setup program can be activated in one of two ways:

1. By pressing <Delete> immediately after turning the system on, or
2. When the message shown below appears briefly at the bottom of the screen during the POST (Power On Self-Test), press the <Delete> key to activate the main Setup menu:

Press the <Delete> key to enter Setup

4-3 Main BIOS Setup

All main Setup options are described in this section. The main BIOS Setup screen is displayed below.

Use the Up/Down arrow keys to move among the different settings in each menu. Use the Left/Right arrow keys to change the options for each setting.

Press the <Esc> key to exit the CMOS Setup Menu. The next section describes in detail how to navigate through the menus.

Items that use submenus are indicated with the ► icon. With the item highlighted, press the <Enter> key to access the submenu.

Main BIOS Setup Menu

PhoenixBIOS Setup - Copyright 1985-2004 Phoenix Technologies Ltd.				
Main	Advanced	Security	Boot	Exit
System Time:	[15:25:15]			Item Specific Help <Tab>, <Shift-Tab>, or <Enter> selects field.
System Date:	[05-04-2006]			
BIOS Date				
Legacy Diskette A:	[1.44/1.25 MB]			
▶ IDE Channel 0 Master	[CD-ROM]			
IDE Channel 0 Slave	[None]			
▶ IDE Channel 1 Master	[None]			
IDE Channel 1 Slave	[None]			
SATA Port 2				
SATA Port 3				
Parallel ATA:	[Enabled]			
Serial ATA:	[Enabled]			
Native Mode Operation:	[Auto]			
SATA Controller Mode Option:	[Compatible]			
System Memory:	[XXXX KB]			
Extended Memory:	[XXXX KB]			
F1 Help ↑↓ Select Item -/+ Change Values F9 Setup Defaults Esc Exit ←→ Select Menu Enter Select ▶ Sub-Menu F10 Previous Values				

Main Setup Features

System Time

To set the system date and time, key in the correct information in the appropriate fields. Then press the <Enter> key to save the data.

System Date

Using the arrow keys, highlight the month, day and year fields, and enter the correct data. Press the <Enter> key to save the data.

BIOS Date

This field displays the date when this version of BIOS was built.

Legacy Diskette A

This setting allows the user to set the type of floppy disk drive installed as diskette A. The options are Disabled, 360Kb 5.25 in, 1.2MB 5.25 in, 720Kb 3.5 in, **1.44/1.25MB**, 3.5 in and 2.88MB 3.5 in.

► IDE Channel 0 Master/Slave, IDE Channel 1 Master/Slave, SATA Port2 and SATA Port3

These settings allow the user to set the parameters of IDE Channel 0 Master/Slave, IDE Channel 1 Master/Slave, IDE Channel 2 Master, IDE Channel 3 Master slots. Hit <Enter> to activate the following sub-menu screen for detailed options of these items. Set the correct configurations accordingly. The items included in the sub-menu are:

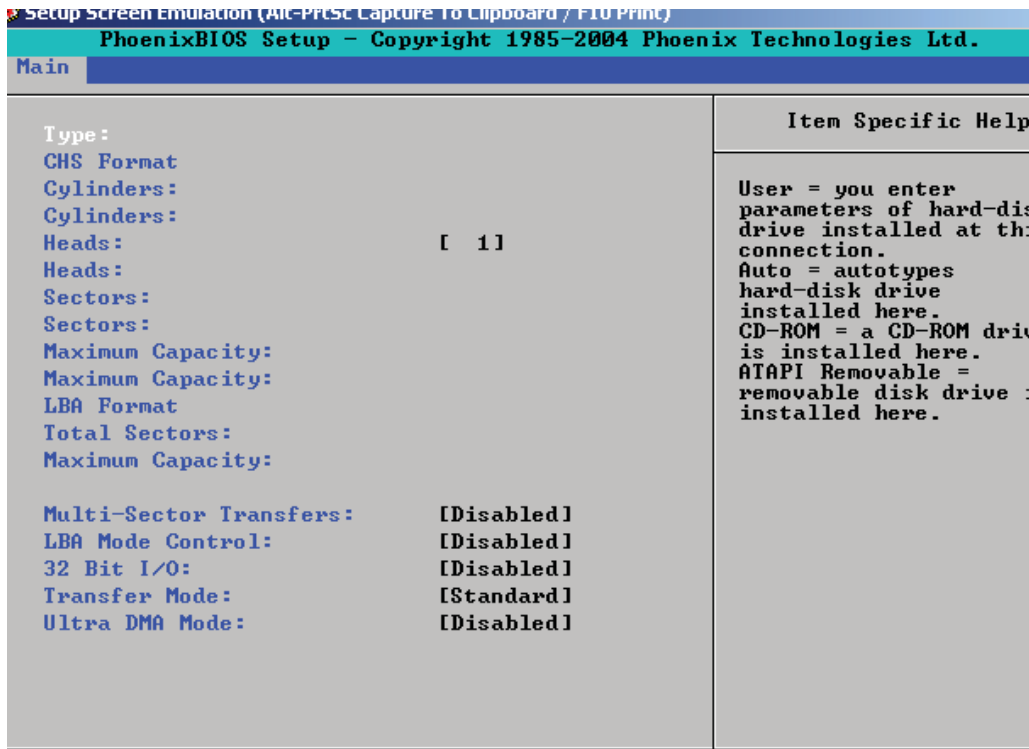

Type

This item allows you to select the type of IDE hard drive. Select **Auto** to allow the BIOS to automatically determine the hard drive's capacity, number of heads, etc.). Enter a number from 1-39 to select a predetermined type of hard drive. Select User to allow the user to enter the parameters of the HDD installed at this connection. Select CDROM if a CDROM drive is installed. Select ATAPI if a removable disk drive is installed.

CHS Format

The following items will be displayed by the BIOS:

TYPE: This item displays the type of IDE or SATA Device.

Cylinders: This item indicates the status of Cylinders.

Headers: This item indicates the number of headers.

Sectors: This item displays the number of sectors.

Maximum Capacity: This item displays the maximum storage capacity of the system.

LBA Format

The following items will be displayed by the BIOS:

Total Sectors: This item displays the number of total sectors available in the LBA Format.

Maximum Capacity: This item displays the maximum capacity in the LBA Format.

Multi-Sector Transfers

This item allows the user to specify the number of sectors per block to be used in multi-sector transfer. The options are **Disabled**, 4 Sectors, 8 Sectors, and 16 Sectors.

LBA Mode Control

This item determines whether the Phoenix BIOS will access the IDE Channel 0 Master Device via the LBA mode. The options are Enabled and **Disabled**.

32 Bit I/O

This option allows the user to enable or disable the function of 32-bit data transfer. The options are Enabled and **Disabled**.

Transfer Mode

This option allows the user to set the transfer mode. The options are **Standard**, Fast PIO1, Fast PIO2, Fast PIO3, Fast PIO4, FPIO3/DMA1 and FPIO4/DMA2.

Ultra DMA Mode

This option allows the user to select Ultra DMA Mode. The options are **Disabled**, Mode 0, Mode 1, Mode 2, Mode 3, Mode 4, and Mode 5.

Parallel ATA

This setting allows the user to enable or disable the function of Parallel ATA. The options are Disabled, **Channel 0**, Channel 1, and Both.

Serial ATA

This setting allows the user to enable or disable the function of Serial ATA. The options are Disabled and **Enabled**.

Native Mode Operation

Select the native mode for ATA. The options are: Parallel ATA, Serial ATA, Both, and **Auto**.

SATA Controller Mode

Select **Compatible** to allow the SATA and PATA drives to be automatically-detected and be placed in the Legacy Mode by the BIOS. Select Enhanced to allow the SATA and PATA drives to be to be automatically-detected and be placed in the Native IDE Mode. (**Note: The Enhanced mode is supported by the Windows 2000 OS or a later version.**)

When the SATA Controller Mode is set to "Enhanced", the following items will display:

Serial ATA (SATA) RAID Enable

Select Enable to enable Serial ATA RAID Functions. (*For the Windows OS environment, use the RAID driver if this feature is set to Enabled. When this item is set to Enabled, the item: "ICH RAID Code Base" will be available for you to select either Intel or Adaptec Host RAID firmware to be activated. If this item is set to **Disabled**, the item-SATA AHCI Enable will be available.) The options are Enabled and **Disabled**.

ICH RAID Code Base

Select Intel to enable Intel's SATA RAID firmware. Select Adaptec to use Adaptec's HostRAID firmware. The options are **Intel** and Adaptec.

SATA AHCI

Select Enable to enable the function of Serial ATA Advanced Host Interface. (*Take caution when using this function. This feature is for advanced programmers only. The options are Enabled and **Disabled**.)

System Memory

This display informs you how much system memory is recognized as being present in the system.

Extended Memory

This display informs you how much extended memory is recognized as being present in the system.

4-4 Advanced Setup

Choose Advanced from the Phoenix BIOS Setup Utility main menu with the arrow keys. You should see the following display. The items with a triangle beside them have sub menus that can be accessed by highlighting the item and pressing <Enter>.

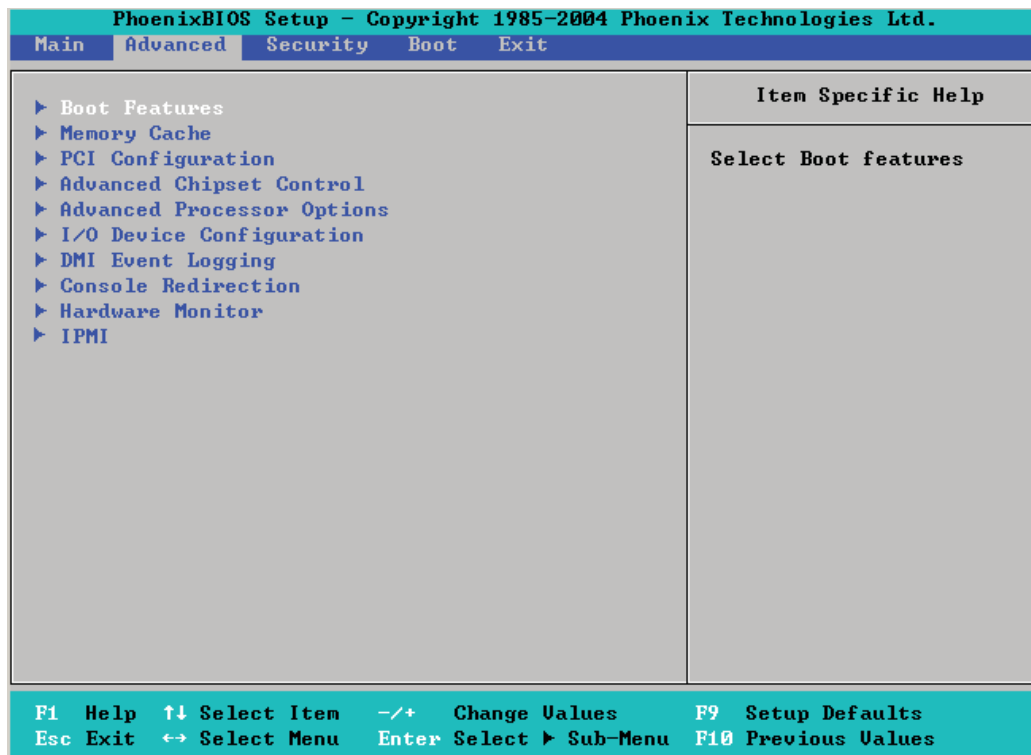

► Boot Features

Access the submenu to make changes to the following settings.

Quick Boot Mode

If enabled, this feature will speed up the POST (Power On Self Test) routine by skipping certain tests after the computer is turned on. The settings are **Enabled** and **Disabled**. If **Disabled**, the POST routine will run at normal speed.

Quiet Boot

This setting allows you to **Enable** or **Disable** the graphic logo screen during boot-up.

ACPI Mode

Use the setting to determine if you want to employ ACPI (Advanced Configuration and Power Interface) power management on your system. The options are **Yes** and **No**.

Power Button Behavior

If set to **Instant-Off**, the system will power off immediately as soon as the user hits the power button. If set to **4-sec.**, the system will power off when the user presses the power button for 4 seconds or longer. The options are **instant-off** and **4-sec override**.

Resume On Modem Ring

Select **On** to “wake your system up” when an incoming call is received by your modem. The options are **On** and **Off**.

Power Loss Control

This setting allows you to choose how the system will react when power returns after an unexpected loss of power. The options are **Stay Off**, **Power On**, and **Last State**.

Watch Dog

If enabled, this option will automatically reset the system if the system is not active for more than 5 minutes. The options are **Enabled** and **Disabled**.

Summary Screen

This setting allows you to **Enable** or **Disable** the summary screen which displays the system configuration during bootup.

► Memory Cache

Cache System BIOS Area

This setting allows you to designate a reserve area in the system memory to be used as a System BIOS buffer to allow the BIOS to write (cache) data into this reserved memory area. Select **Write Protect** to enable this function, and this area will be reserved for BIOS ROM access only. Select "Uncached" to disable this function and make this area available for other devices.

Cache Video BIOS Area

This setting allows you to designate a reserve area in the system memory to be used as a Video BIOS buffer to allow the BIOS to write (cache) data into this reserved memory area. Select **Write Protect** to enable the function and this area will be reserved for Video BIOS ROM access only. Select Uncached to disable this function and make this area available for other devices.

Cache Base 0-512K

If enabled, this feature will allow the data stored in the base memory area: block 0-512K to be cached (written) into a buffer, a storage area in the Static DRAM (SDRAM) or to be written into L1, L2 cache inside the CPU to speed up CPU operations. Select Uncached to disable this function. Select Write Through to allow data to be cached into the buffer and written into the system memory at the same time. Select Write Protect to prevent data from being written into the base memory area of Block 0-512K. Select Write Back to allow the CPU to write data back directly from the buffer without writing data to the System Memory for fast CPU data processing and operation. The options are Uncached, Write Through, Write Protect, and **Write Back**.

Cache Base 512K-640K

If enabled, this feature will allow the data stored in the memory area: 512K-640K to be cached (written) into a buffer, a storage area in the Static DRAM (SDRAM) or written into L1, L2, L3 cache inside the CPU to speed up CPU operations. Select Uncached to disable this function. Select Write Through to allow data to be cached into the buffer and written into the system memory at the same time. Select Write Protect to prevent data from being written into the base memory area of Block 512-640K. Select Write Back to allow the CPU to write data back directly from the buffer without writing data to the System Memory for fast CPU data processing and operation. The options are Uncached, Write Through, Write Protect, and **Write Back**.

Cache Extended Memory

If enabled, this feature will allow the data stored in the extended memory area to be cached (written) into a buffer, a storage area in the Static DRAM (SDRAM) or

written into L1, L2, L3 cache inside the CPU to speed up CPU operations. Select Uncached to disable this function. Select Write Through to allow data to be cached into the buffer and written into the system memory at the same time. Select Write Protect to prevent data from being written into the extended memory area above 1 MB. Select Write Back to allow the CPU to write data back directly from the buffer without writing data to the System Memory for fast CPU data processing and operation. The options are Uncached, Write Through, Write Protect, and **Write Back**.

Discrete MTRR Allocation

If enabled, MTRRs (-Memory Type Range Registers) are configured as distinct, separate units and cannot be overlapped. If enabled, the user can achieve better graphic effects when using a Linux graphic driver that requires the write-combining configuration with 4GB or more memory. The options are Enabled and **Disabled**.

► PCI Configuration

Access the submenu to make changes to the following settings for PCI devices.

Onboard GLAN1/Onboard GLAN2 (Gigabit- LAN) OPROM Configure

Enabling this option provides the capability to boot from GLAN. The options are **Disabled** and Enabled.

Onboard SCSI OPROM Configure

Enabling this option provides the capability to boot from SCSI HDD. The options are Disabled and **Enabled**.

PCI Parity Error Forwarding

The feature allows SERR and PERR errors detected in PCI slots to be sent (forwarded) to the BIOS DMI Event Log for the user to review. The options are Enabled and **Disabled**.

Reset Configuration Data

If set to Yes, this setting clears the Extended System Configuration Data- (ESCD) area. The options are Yes and **No**.

Frequency for PCI-X#1, PCI-X#2, PCI-X#3

This option allows the user to change the bus frequency for the devices installed in the slot indicated. The options are **Auto**, PCI 33 MHz, PCI 66 MHz, PCI-X 66 MHz, PCI-X 100 MHz, and PCI-X 133 MHz.

Frequency for PCI-X#1 On Riser, Frequency for PCI-X#2-#3 On Riser (Available when an Active Riser Card is present.)

This option allows the user to change the bus frequency of the devices installed in the slot indicated. The options are **Auto**, PCI 33 MHz, PCI 66 MHz, PCI-X 66 MHz, PCI-X 100 MHz, and PCI-X 133 MHz.

► **Slot1 PCI-X 100 MHz ZCR, Slot2 PCI-X 133MHz, Slot3 PCI-X 133MHz, Slot4 PCI-Exp x4, Slot5 PCI-Exp x8, and Slot6 PCI-Exp x8**

Access the submenu for each of the settings above to make changes to the following:

Option ROM Scan

When enabled, this setting will initialize the device expansion ROM. The options are **Enabled** and Disabled.

Enable Master

This setting allows you to enable the selected device as the PCI bus master. The options are **Enabled** and Disabled.

Latency Timer

This setting allows you to set the clock rate for Bus Master. A high-priority, high-throughput device may benefit from a greater clock rate. The options are **Default**, 0020h, 0040h, 0060h, 0080h, 00A0h, 00C0h, and 00E0h. For Unix, Novell and other Operating Systems, please select the option: other. If a drive fails after the installation of a new software, you might want to change this setting and try again. A different OS requires a different Bus Master clock rate.

Large Disk Access Mode

This setting determines how large hard drives are to be accessed. The options are **DOS** or Other (for Unix, Novelle NetWare and other operating systems).

► **Advanced Chipset Control**

Access the submenu to make changes to the following settings.



Warning: Take Caution when changing the Advanced settings. An incorrect setting, a very high DRAM frequency or an incorrect DRAM timing may cause system to become instable When this occurs, reset the setting to its default setting.

SERR Signal Condition

This setting specifies the ECC Error conditions that an SERR# is to be asserted. The options are None, **Single Bit**, Multiple Bit, and Both.

4GB PCI Hole Granularity

This feature allows you to select the granularity of PCI hole for PCI slots. If MTRRs are not enough, this option may be used to reduce MTRR occupation. The options are: **256 MB**, 512 MB, 1GB and 2GB.

Memory Branch Mode

This option determines how the two memory branches operate. System address space can either be interleaved between the two branches or Sequential from one branch to another. Mirror mode allows data correction by maintaining two copies of data in two branches. Single Channel 0 allows a single DIMM population during system manufacturing. The options are **Interleave**, Sequential, Mirroring, and Single Channel 0.

Branch 0 Rank Sparing

Select enable to enable the sparing feature for Branch 0 Rank. The options are Enabled and **Disabled**.

Branch 1 Rank Sparing

Select enable to enable the sparing feature for Branch 0 Rank. The options are Enabled and **Disabled**.

Enhanced x8 Detection

Select **Enabled** to enable Enhanced x8 DRAM UC Error Detection. The options are Disabled and **Enabled**.

Crystal Beach Features

This feature cooperates with Intel I/O AT (Acceleration Technology) to accelerate the performance of TOE devices. (Note: A TOE device is a specialized, dedicated processor that is installed on an add-on card or a network card to handle some or all packet processing of this add-on card. For the X7DB8/E, the TOE device is built inside the ESB 2 South Bridge chip.) The options are **Enabled** and Disabled.

Route Port 80h Cycles to

This feature allows the user to decide which bus to send debug information to. The options are Disabled, PCI and **LPC**.

Clock Spectrum Feature

If Enabled, the BIOS will monitor the level of Electromagnetic Interference caused by the components and will attempt to decrease the interference whenever needed. The options are Enabled and **Disabled**.

Enabling Multi-Media Timer

Select Yes to activate a set of timers that are alternative to the traditional 8254 timers for the OS use. The options are Yes and **No**.

USB Function

Select Enabled to enable the function of USB devices specified. The settings are **Enabled** and Disabled.

Legacy USB Support

This setting allows you to enable support for Legacy USB devices. The settings are **Enabled** and Disabled.

► Advanced Processor Options

Access the submenu to make changes to the following settings.

CPU Speed

This is a display that indicates the speed of the installed processor.

Frequency Ratio (Available if supported by the CPU.)

The feature allows the user to set the internal frequency multiplier for the CPU. The options are: **Default**, x12, x13, x14, x15, x16, x17 and x18.

Hyper-threading (Available if supported by the CPU.)

Set to Enabled to use the Hyper-Threading Technology, which will result in increased CPU performance. The options are Disabled and **Enabled**.

Core-Multi-Processing (Available if supported by the CPU.)

Set to Enabled to use a processor's Second Core and beyond. (Please refer to Intel's web site for more information.) The options are Disabled and **Enabled**.

Machine Checking (Available if supported by the CPU.)

Set to Enabled to activate the function of Machine Checking and allow the CPU to detect and report hardware (machine) errors via a set of model-specific registers (MSRs). The options are Disabled and **Enabled**.

Thermal Management 2 (Available if supported by the CPU.)

Set to **Enabled** to use Thermal Management 2 (TM2) which will lower CPU voltage and frequency when the CPU temperature reaches a predefined overheat threshold. Set to Disabled to use Thermal Manager 1 (TM1), allowing CPU clocking to be regulated via CPU Internal Clock modulation when the CPU temperature reaches the overheat threshold.

C1 Enhanced Mode (Available if supported by the CPU.)

Set to Enabled to enable Enhanced Halt State to lower CPU voltage/frequency to prevent overheat. The options are Enabled and **Disabled**. (**Note:** please refer to Intel's web site for detailed information.)

No Execute Mode Memory Protection (Available if supported by the CPU and the OS.)

Set to Enabled to enable Execute Disable Bit and allow the processor to classify areas in memory where an application code can execute and where it cannot, and thus preventing a worm or a virus from inserting and creating a flood of codes to overwhelm the processor or damage the system during an attack.

Note: this feature is available when your OS and your CPU support the function of Execute Disable Bit.) The options are **Disabled** and Enabled. **Note:** For more information regarding hardware/software support for this function, please refer to Intel's and Microsoft's web sites.

Adjacent Cache Line Prefetch (Available if supported by the CPU.)

The CPU fetches the cache line for 64 bytes if this option is set to Disabled. The CPU fetches both cache lines for 128 bytes as comprised if Enabled. The options are **Disabled** and Enabled.

Hardware Prefetch (Available if supported by the CPU.)

Set to this option to **enabled** to enable the hardware components that are used in conjunction with software programs to prefetch data in order to shorten execution cycles and maximize data processing efficiency. The options are Disabled and **Enabled**.

PECI Absent Alarm (Available if supported by the CPU.)

If set to **Enabled**, the PECI Absent Alarm will be activated if the function of PECI (Platform Environment Control Interface) is not available for the onboard process(s) or for the motherboard. The options are Disabled and **Enabled**.

Intel <R> Virtualization Technology (Available if supported by the CPU.)

Select Enabled to use the feature of Virtualization Technology to allow one platform to run multiple operating systems and applications in independent partitions, creating multiple "virtual" systems in one physical computer. The options are Enabled and **Disabled**. (Note: If there is any change to this setting, you will need to power off and restart the system for the change to take effect.) Please refer to Intel's web site for detailed information.

Intel EIST Support (Available if supported by the CPU.)

Select Enabled to use the Enhanced Intel SpeedStep Technology and allows the system to automatically adjust processor voltage and core frequency in an effort to reduce power consumption and heat dissipation. The options are Enabled and **Disabled**. Please refer to Intel's web site for detailed information.

► I/O Device Configuration

Access the submenu to make changes to the following settings.

KBC Clock Input

This setting allows you to select clock frequency for KBC. The options are 6MHz, 8MHz, **12MHz**, and 16MHz.

Serial Port A

This setting allows you to assign control of serial port A. The options are **Enabled** (user defined), Disabled, and Auto (BIOS- or OS- controlled).

Base I/O Address

This setting allows you to select the base I/O address for serial port A. The options are **3F8**, 2F8, 3E8, and 2E8.

Interrupt

This setting allows you to select the IRQ (interrupt request) for serial port A. The options are IRQ3 and **IRQ4**.

Serial Port B

This setting allows you to assign control of serial port B. The options are **Enabled** (user defined), Disabled, Auto (BIOS controlled) and OS Controlled.

Mode

This setting allows you to set the type of device that will be connected to serial port B. The options are **Normal** and IR (for an infrared device).

Base I/O Address

This setting allows you to select the base I/O address for serial port B. The options are 3F8, **2F8**, 3E8 and 2E8.

Interrupt

This setting allows you to select the IRQ (interrupt request) for serial port B. The options are **IRQ3** and IRQ4.

Parallel Port

This setting allows you to assign control of the parallel port. The options are **Enabled** (user defined), Disabled and Auto (BIOS-or OS- controlled).

Base I/O Address

Select the base I/O address for the parallel port. The options are **378**, 278 and 3BC.

Interrupt

This setting allows you to select the IRQ (interrupt request) for the parallel port. The options are IRQ5 and **IRQ7**.

Mode

This feature allows you to specify the parallel port mode. The options are Output only, Bi-Directional, EPP and **ECP**.

DMA Channel

This item allows you to specify the DMA channel for the parallel port. The options are DMA1 and **DMA3**.

Floppy Disk Controller

This setting allows you to assign control of the floppy disk controller. The options are **Enabled** (user defined), Disabled, and Auto (BIOS and OS controlled).

Base I/O Address

This setting allows you to select the base I/O address for the Floppy port. The options are **Primary** and Secondary.

► DMI Event Logging

Access the submenu to make changes to the following settings.

Event Log Validity

This is a display to inform you of the event log validity. It is not a setting.

Event Log Capacity

This is a display to inform you of the event log capacity. It is not a setting.

View DMI Event Log

Highlight this item and press <Enter> to view the contents of the event log.

Event Logging

This setting allows you to **Enable** or Disable event logging.

ECC Event Logging

This setting allows you to **Enable** or Disable ECC event logging.

Mark DMI Events as Read

Highlight this item and press <Enter> to mark the DMI events as read.

Clear All DMI Event Logs

Select Yes and press <Enter> to clear all DMI event logs. The options are Yes and **No**.

► Console Redirection

Access the submenu to make changes to the following settings.

COM Port Address

This item allows you to specify which COM port to direct the remote console to: Onboard COM A or Onboard COM B. This setting can also be **Disabled**.

BAUD Rate

This item allows you to set the BAUD rate for the console redirection. The options are 300, 1200, 2400, 9600, **19.2K**, 38.4K, 57.6K, and 115.2K.

Console Type

This item allows you to choose the console redirection type. The options are VT100, VT100,8bit, PC-ANSI, 7bit, **PC ANSI**, VT100+, and VT-UTF8.

Flow Control

This item allows you to set the flow control for the console redirection. The options are: None, XON/XOFF, and **CTS/RTS**.

Console Connection

This item allows you to decide how the console redirection is to be connected: either **Direct** or Via Modem.

Continue CR after POST

This item allows you to decide whether you want to continue with console redirection after POST routines. The options are On and **Off**.

► Hardware Monitor Logic

Note: The Phoenix BIOS will automatically detect the type of CPU(s) and hardware monitoring chip used on the motherboard and will display the Hardware Monitoring Screen accordingly. Your Hardware Monitoring Screen may look like the one shown on this page, on P. 4-19, or on P. 4-20, depending on the type of CPU(s) and HW Monitoring chip you are using.

CPU Temperature Threshold

This option allows the user to set a CPU temperature threshold that will activate the alarm system when the CPU temperature reaches this pre-set temperature threshold. The options are **75°C**, 80°C, 85°C and 90°C. (See the note below.)

Highlight this and hit <Enter> to see monitor data for the following items:

CPU1 Temperature/CPU1 Second Core

CPU2 Temperature/CPU2 Second Core

System Temperature

Fan1-Fan8 Speeds: If the feature of Auto Fan Control is enabled, the BIOS will automatically display the status of the fans indicated in this item.

Fan Speed Control Modes

This feature allows the user to decide how the system controls the speeds of the onboard fans. The CPU temperature and the fan speed are correlative. When the CPU on-die temperature increases, the fan speed will also increase, and vice versa. If the option is set to “3-pin fan”, the fan speed is controlled by voltage. If the option is set to “4-pin”, the fan speed will be controlled by Pulse Width Modulation (PWM). Select “3-pin” if your chassis came with 3-pin fan headers. Select “4-pin” if your chassis came with 4-pin fan headers. Select “Workstation” if your system is used as a Workstation. Select “Server” if your system is used as a Server. Select “Disable” to disable the fan speed control function to allow the onboard fans to constantly run at full speed (12V). The Options are: **1. Disable**, 2. 3-pin (Server), 3. 3-pin (Workstation), 4. 4-pin (Server) and 5. 4-pin (Workstation).

Voltage Monitoring

The following items will be monitored and displayed:

P12V_VR0/P12V_VR1

FSB VTT/PXH Vcore/ES2B Vcore

CPU1Vcore/CPU2Vcore

P3V3

Note: In the Windows OS environment, the Supero Doctor III settings take precedence over the BIOS settings. When first installed, Supero Doctor III adopts the temperature threshold settings previously set in the BIOS. Any subsequent changes to these thresholds must be made within Supero Doctor, since the SD III settings override the BIOS settings. For the Windows OS to adopt the BIOS temperature threshold settings, please change the SDIII settings to be the same as those set in the BIOS.

► Hardware Monitor Logic

CPU Temperature Threshold (*See the Note on Page 4-18.)

This option allows the user to set a CPU temperature threshold that will activate the alarm system when the CPU temperature reaches this pre-set temperature threshold. The options are **75°C**, 80°C, 85°C and 90°C (See the note below.)

Highlight this and hit <Enter> to see monitor data for the following items:

CPU1 Temperature/CPU1 Second Core

CPU2 Temperature/CPU2 Second Core

System Temperature

Fan1-Fan8 Speeds: If the feature of Auto Fan Control is enabled, the BIOS will automatically display the status of the fans indicated in this item.

Fan Speed Control Modes

This feature allows the user to decide how the system controls the speeds of the onboard fans. The CPU temperature and the fan speed are correlative. When the CPU on-die temperature increases, the fan speed will also increase, and vice versa. If the option is set to “3-pin fan”, the fan speed is controlled by voltage. If the option is set to “4-pin”, the fan speed will be controlled by Pulse Width Modulation (PWM). Select “3-pin” if your chassis came with 3-pin fan headers. Select “4-pin” if your chassis came with 4-pin fan headers. Select “Workstation” if your system is used as a Workstation. Select “Server” if your system is used as a Server. Select “Disable” to disable the fan speed control function to allow the onboard fans to constantly run at full speed (12V). The Options are: **1. Disable**, 2. 3-pin (Server), 3. 3-pin (Workstation), 4. 4-pin (Server) and 5. 4-pin (Workstation).

Voltage Monitoring

The following items will be monitored and displayed:

Vcore A/Vcore B

-12V/+12V

P1V5

+3.3V

5Vsb/5VDD

P_VTT

Vbat

Note: In the Windows OS environment, the Supero Doctor III settings take precedence over the BIOS settings. When first installed, Supero Doctor III adopts the temperature threshold settings previously set in the BIOS. Any subsequent changes to these thresholds must be made within Supero Doctor, since the SD III settings override the BIOS settings. For the Windows OS to adopt the BIOS temperature threshold settings, please change the SDIII settings to be the same as those set in the BIOS.

► Hardware Monitor Logic (*See the Note on Page 4-18.)**CPU Temperature Threshold**

This option indicates a CPU temperature threshold that will activate the alarm system when the CPU temperature reaches this pre-set temperature threshold. The hardcode default setting is **75°C**. (*See the note below.)

Temperature Monitoring

Highlight this and hit <Enter> to see monitor data for the following items:

PECI Agent 1 Temperature/PECI Agent 2 Temperature**PECI Agent 3 Temperature/PECI Agent 4 Temperature****System Temperature**

Fan1-Fan8 Speeds: If the feature of Auto Fan Control is enabled, the BIOS will automatically display the status of the fans indicated in this item.

Fan Speed Control Modes

This feature allows the user to decide how the system controls the speeds of the onboard fans. The CPU temperature and the fan speed are correlative. When the CPU on-die temperature increases, the fan speed will also increase, and vice versa. If the option is set to “3-pin fan”, the fan speed is controlled by voltage. If the option is set to “4-pin”, the fan speed will be controlled by Pulse Width Modulation (PWM). Select “3-pin” if your chassis came with 3-pin fan headers. Select “4-pin” if your chassis came with 4-pin fan headers. Select “Workstation” if your system is used as a Workstation. Select “Server” if your system is used as a Server. Select “Disable” to disable the fan speed control function to allow the onboard fans to constantly run at full speed (12V). The Options are: **1. Disable**, 2. 3-pin (Server), 3. 3-pin (Workstation), 4. 4-pin (Server) and 5. 4-pin (Workstation).

Voltage Monitoring

The following items will be monitored and displayed:

Vcore A:/Vcore B:

-12V/+12V

P1V2_NIC_SEN

+3.3V

5Vsb/5VDD

P_VTT/Vbat

Note: In the Windows OS environment, the Supero Doctor III settings take precedence over the BIOS settings. When first installed, Supero Doctor III adopts the temperature threshold settings previously set in the BIOS. Any subsequent changes to these thresholds must be made within Supero Doctor, since the SD III settings override the BIOS settings. For the Windows OS to adopt the BIOS temperature threshold settings, please change the SDIII settings to be the same as those set in the BIOS.

► **IPMI** (The option is available only when an IPMI card is installed in the system.)

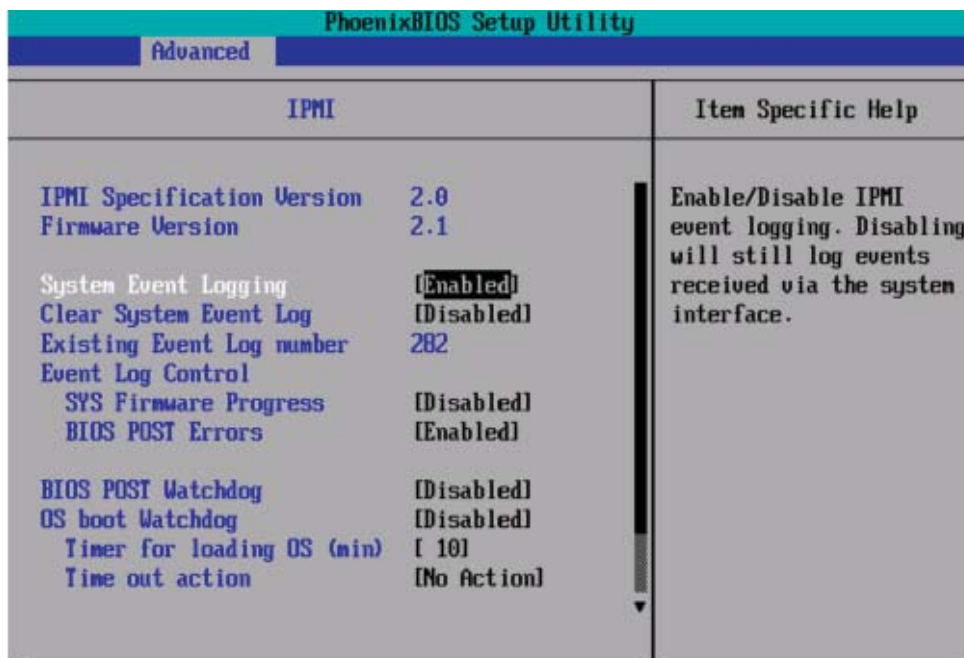

IPMI Specification Version: This item displays the current IPMI Version.

Firmware Version: This item displays the current Firmware Version.

System Event Logging

Select Enabled to enable IPMI Event Logging. When this function is set to Disabled, the system will continue to log events received via system interface. The options are **Enabled** and Disabled.

Clear System Event Logging

Enabling this function to force the BIOS to clear the system event logs during the next cold boot. The options are Enabled and **Disabled**.

Existing Event Log Number

This item displays the number of the existing event log.

Event Log Control

System Firmware Progress

Enabling this function to log POST progress. The options are Enabled and **Disabled**.

BIOS POST Errors

Enabling this function to log POST errors. The options are Enabled and **Disabled**.

BIOS POST Watch Dog

Set to Enabled to enable POST Watch Dog. The options are Enabled and **Disabled**.

OS Boot Watch Dog

Set to Enabled to enable OS Boot Watch Dog. The options are Enabled and Disabled.

Timer for Loading OS (Minutes)

This feature allows the user to set the time value (in minutes) for the previous item: OS Boot Watch Dog by keying-in a desired number in the blank. The default setting is 10 (minutes.) (Please ignore this option when OS Boot Watch Dog is set to "Disabled".)

Time Out Option

This feature allows the user to determine what action to take in an event of a system boot failure. The options are **No Action**, Reset, Power Off and Power Cycles.

► System Event Log/System Event Log (List Mode)

These options display the System Event (SEL) Log and System Event (SEL) Log in List Mode. Items include: SEL (System Event Log) Entry Number, SEL Record ID, SEL Record Type, Time Stamp, Generator ID, SEL Message Revision, Sensor Type, Sensor Number, SEL Event Type, Event Description, and SEL Event Data.

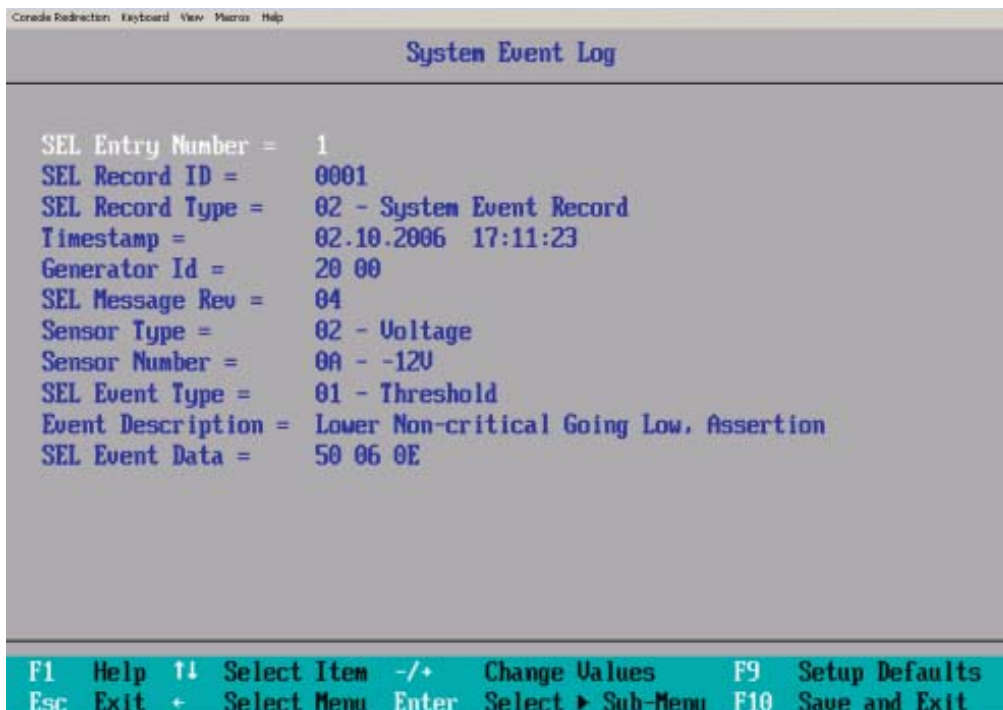

► Realtime Sensor Data

This feature display information from motherboard sensors, such as temperatures, fan speeds and voltages of various components.

Realtime Sensor Data					
Sensor Type	Sensor Name	Sensor Data	Sensor Units	Lower Limit	Upper Limit
Temp					
	CPU1 CoreA	48.00	degrees C	0.00	75.00
	CPU1 CoreB	54.00	degrees C	0.00	75.00
	CPU2 CoreA	47.00	degrees C	0.00	75.00
	CPU2 CoreB	46.00	degrees C	0.00	75.00
	System	44.00	degrees C	0.00	75.00
Voltage					
	CPU1 Core	1.13	Volts	0.97	1.47
	CPU2 Core	1.16	Volts	0.97	1.47
	3.3V	3.30	Volts	2.95	3.62

F1	Help	↑↓	Select Item	-/+	Change Values	F9	Setup Defaults
Esc	Exit	←	Select Menu	Enter	Select ► Sub-Menu	F10	Save and Exit

4-5 Security

Choose Security from the Phoenix BIOS Setup Utility main menu with the arrow keys. You should see the following display. Security setting options are displayed by highlighting the setting using the arrow keys and pressing <Enter>. All Security BIOS settings are described in this section.

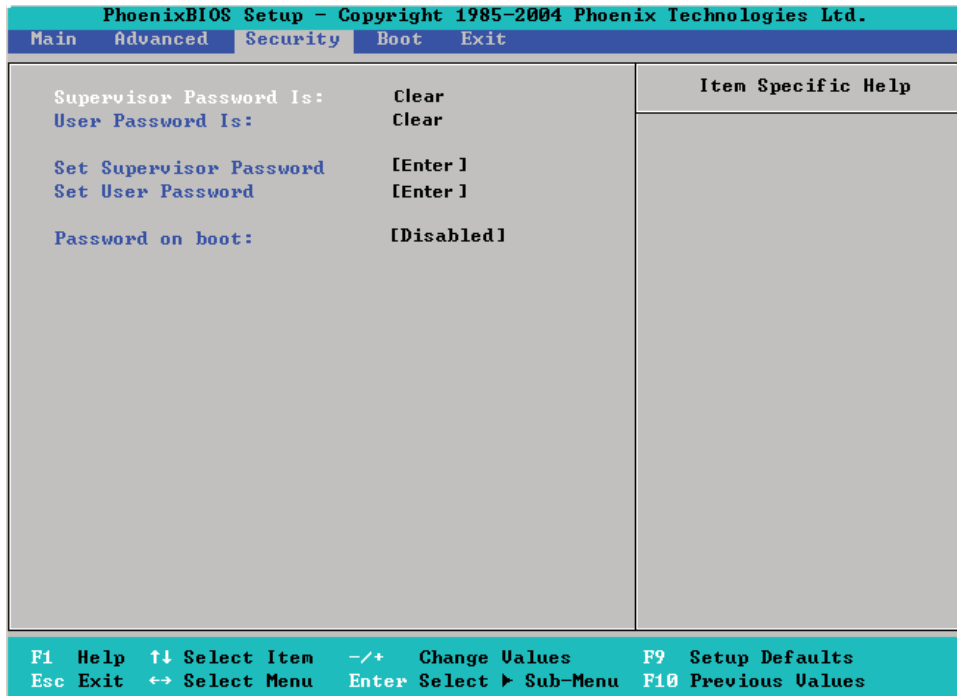

Supervisor Password Is:

This item indicates if a supervisor password has been entered for the system. Clear means such a password has not been used and Set means a supervisor password has been entered for the system.

User Password Is:

This item indicates if a user password has been entered for the system. Clear means such a password has not been used and Set means a user password has been entered for the system.

Set Supervisor Password

When the item "Set Supervisor Password" is highlighted, hit the <Enter> key. When prompted, type the Supervisor's password in the dialogue box to set or to change supervisor's password, which allows access to the BIOS.

Set User Password

When the item "Set User Password" is highlighted, hit the <Enter> key. When prompted, type the user's password in the dialogue box to set or to change the user's password, which allows access to the system at boot-up.

Password on Boot

This setting allows you to determine if a password is required for a user to enter the system at system boot. The options are **Enabled** (password required) and **Disabled** (password not required).

4-6 Boot

Choose Boot from the Phoenix BIOS Setup Utility main menu with the arrow keys. You should see the following display. See details on how to change the order and specs of boot devices in the Item Specific Help window. All Boot BIOS settings are described in this section.

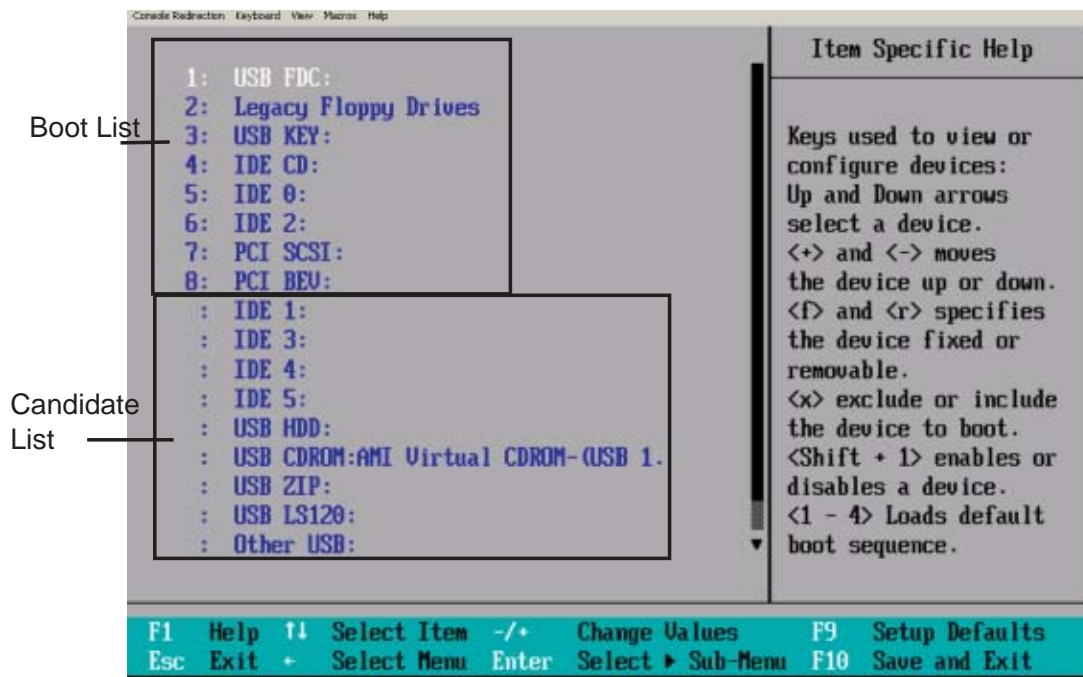

Boot Priority Order/Excluded from Boot Orders

The devices included in the boot list section (above) are bootable devices listed in the sequence of boot order as specified. The boot functions for the devices included in the candidate list (above) are currently disabled. Use a <+> key or a <-> key to move the device up or down. Use the <f> key or the <r> key to specify the type of an USB device, either fixed or removable. You can select one item from the boot list and hit the <x> key to remove it from the list of bootable devices (to make its resource available for other bootable devices). Subsequently, you can select an item from the candidate list and hit the <x> key to remove it from the candidate list and put it in the boot list. This item will then become a bootable device. See details on how to change the priority of boot order of devices in the "Item Specific Help" window.

4-7 Exit

Choose Exit from the Phoenix BIOS Setup Utility main menu with the arrow keys. You should see the following display. All Exit BIOS settings are described in this section.

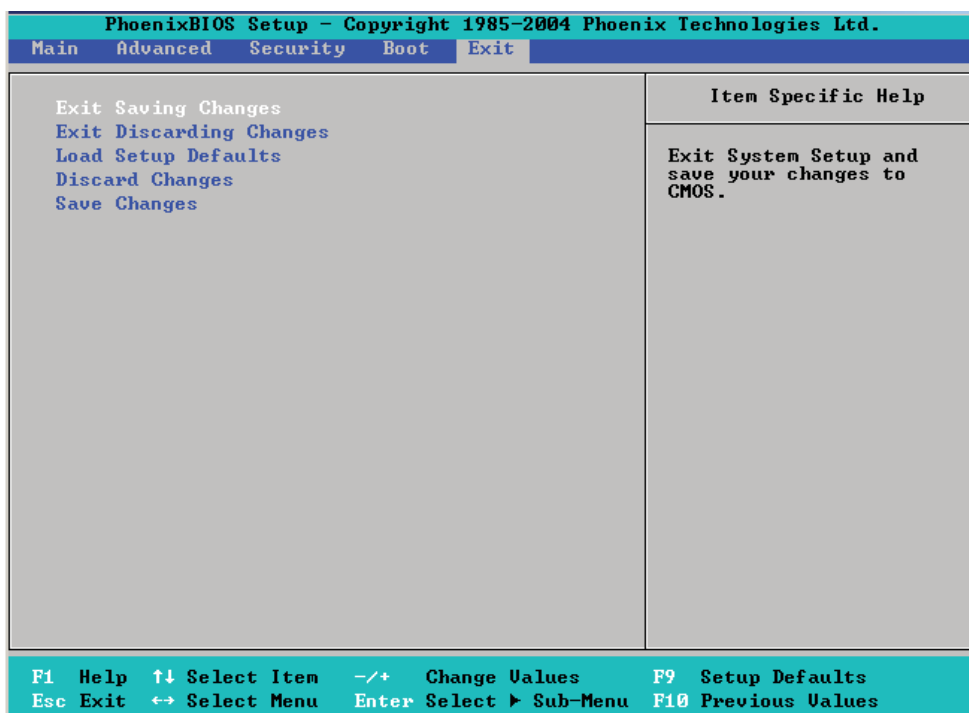

Exit Saving Changes

Highlight this item and hit <Enter> to save any changes you've made and to exit the BIOS Setup utility.

Exit Discarding Changes

Highlight this item and hit <Enter> to exit the BIOS Setup utility without saving any changes you may have made.

Load Setup Defaults

Highlight this item and hit <Enter> to load the default settings for all items in the BIOS Setup. These are the safest settings to use.

Discard Changes

Highlight this item and hit <Enter> to discard (cancel) any changes you've made. You will remain in the Setup utility.

Save Changes

Highlight this item and hit <Enter> to save any changes you made. You will remain in the Setup utility.

Appendix A

BIOS POST Messages

During the Power-On Self-Test (POST), the BIOS will check for problems. If a problem is found, the BIOS will activate an alarm or display a message. The following is a list of such BIOS messages.

Failure Fixed Disk

Fixed disk is not working or not configured properly. Check to see if fixed disk is attached properly. Run Setup. Find out if the fixed-disk type is correctly identified.

Stuck key

Stuck key on keyboard.

Keyboard error

Keyboard not working.

Keyboard Controller Failed

Keyboard controller failed test. May require replacing keyboard controller.

Keyboard locked - Unlock key switch

Unlock the system to proceed.

Monitor type does not match CMOS - Run SETUP

Monitor type not correctly identified in Setup

Shadow Ram Failed at offset: nnnn

Shadow RAM failed at offset **nnnn** of the 64k block at which the error was detected.

System RAM Failed at offset: nnnn

System RAM failed at offset **nnnn** of in the 64k block at which the error was detected.

Extended RAM Failed at offset: nnnn

Extended memory notworking or not configured properly at offset **nnnn**.

System battery is dead - Replace and run SETUP

The CMOS clock battery indicator shows the battery is dead. Replace the battery and run Setup to reconfigure the system.

System CMOS checksum bad - Default configuration used

System CMOS has been corrupted or modified incorrectly, perhaps by an application program that changes data stored in CMOS. The BIOS installed Default Setup Values. If you do not want these values, enter Setup and enter your own values. If the error persists, check the system battery or contact your dealer.

System timer error

The timer test failed. Requires repair of system board.

Real time clock error

Real-Time Clock fails BIOS hardware test. May require board repair.

Check date and time settings

BIOS found date or time out of range and reset the Real-Time Clock. May require setting legal date (1991-2099).

Previous boot incomplete - Default configuration used

Previous POST did not complete successfully. POST loads default values and offers to run Setup. If the failure was caused by incorrect values and they are not corrected, the next boot will likely fail. On systems with control of **wait states**, improper Setup settings can also terminate POST and cause this error on the next boot. Run Setup and verify that the waitstate configuration is correct. This error is cleared the next time the system is booted.

Memory Size found by POST differed from CMOS

Memory size found by POST differed from CMOS.

Diskette drive A error

Diskette drive B error

Drive A: or B: is present but fails the BIOS POST diskette tests. Check to see that the drive is defined with the proper diskette type in Setup and that the diskette drive is attached correctly.

Incorrect Drive A type - run SETUP

Type of floppy drive A: not correctly identified in Setup.

Incorrect Drive B type - run SETUP

Type of floppy drive B: not correctly identified in Setup.

System cache error - Cache disabled

RAM cache failed and BIOS disabled the cache. On older boards, check the cache jumpers. You may have to replace the cache. See your dealer. A disabled cache slows system performance considerably.

CPU ID:

CPU socket number for Multi-Processor error.

EISA CMOS not writeable

ServerBIOS2 test error: Cannot write to EISA CMOS.

DMA Test Failed

ServerBIOS2 test error: Cannot write to extended **DMA** (Direct Memory Access) registers.

Software NMI Failed

ServerBIOS2 test error: Cannot generate software NMI (Non-Maskable Interrupt).

Fail-Safe Timer NMI Failed

ServerBIOS2 test error: Fail-Safe Timer takes too long.

device Address Conflict

Address conflict for specified **device**.

Allocation Error for: device

Run ISA or EISA Configuration Utility to resolve resource conflict for the specified **device**.

CD ROM Drive

CD ROM Drive identified.

Entering SETUP ...

Starting Setup program

Failing Bits: nnnn

The hex number **nnnn** is a map of the bits at the RAM address which failed the memory test. Each 1 (one) in the map indicates a failed bit. See errors 230, 231, or 232 above for offset address of the failure in System, Extended, or Shadow memory.

Fixed Disk n

Fixed disk **n** (0-3) identified.

Invalid System Configuration Data

Problem with NVRAM (CMOS) data.

I/O device IRQ conflict

I/O device IRQ conflict error.

PS/2 Mouse Boot Summary Screen:

PS/2 Mouse installed.

nnnn kB Extended RAM Passed

Where **nnnn** is the amount of RAM in kilobytes successfully tested.

nnnn Cache SRAM Passed

Where **nnnn** is the amount of system cache in kilobytes successfully tested.

nnnn kB Shadow RAM Passed

Where **nnnn** is the amount of shadow RAM in kilobytes successfully tested.

nnnn kB System RAM Passed

Where **nnnn** is the amount of system RAM in kilobytes successfully tested.

One or more I2O Block Storage Devices were excluded from the Setup Boot Menu

There was not enough room in the IPL table to display all installed I2O block-storage devices.

Operating system not found

Operating system cannot be located on either drive A: or drive C:. Enter Setup and see if fixed disk and drive A: are properly identified.

Parity Check 1 nnnn

Parity error found in the system bus. BIOS attempts to locate the address and display it on the screen. If it cannot locate the address, it displays **????**. Parity is a method for checking errors in binary data. A parity error indicates that some data has been corrupted.

Parity Check 2 nnnn

Parity error found in the I/O bus. BIOS attempts to locate the address and display it on the screen. If it cannot locate the address, it displays **????**.

Press <F1> to resume, <F2> to Setup, <F3> for previous

Displayed after any recoverable error message. Press <F1> to start the boot process or <F2> to enter Setup and change the settings. Press <F3> to display the previous screen (usually an initialization error of an **Option ROM**, i.e., an add-on card). Write down and follow the information shown on the screen.

Press <F2> to enter Setup

Optional message displayed during POST. Can be turned off in Setup.

PS/2 Mouse:

PS/2 mouse identified.

Run the I2O Configuration Utility

One or more unclaimed block storage devices have the Configuration Request bit set in the LCT. Run an I2O Configuration Utility (e.g. the SAC utility).

System BIOS shadowed

System BIOS copied to shadow RAM.

UMB upper limit segment address: *nnnn*

Displays the address *nnnn* of the upper limit of **Upper Memory Blocks**, indicating released segments of the BIOS which can be reclaimed by a virtual memory manager.

Video BIOS shadowed

Video BIOS successfully copied to shadow RAM.

Notes

Appendix B

BIOS POST Codes

This section lists the POST (Power On Self Test) codes for the PhoenixBIOS. POST codes are divided into two categories: recoverable and terminal.

Recoverable POST Errors

When a recoverable type of error occurs during POST, the BIOS will display an POST code that describes the problem. BIOS may also issue one of the following beep codes:

- 1 long and two short beeps - video configuration error
- 1 repetitive long beep - no memory detected
- 1 continuous beep (with front panel OH LED on) - system overheat

Terminal POST Errors

If a terminal type of error occurs, BIOS will shut down the system. Before doing so, BIOS will write the error to port 80h, attempt to initialize video and write the error in the top left corner of the screen. The following is a list of codes that may be written to port 80h.

POST Code Description

01h	IPMI Initialization
02h	Verify Real Mode
03h	Disable Non-Maskable Interrupt (NMI)
04h	Get CPU type
06h	Initialize system hardware
07h	Disable shadow and execute code from the ROM.
08h	Initialize chipset with initial POST values
09h	Set IN POST flag
0Ah	Initialize CPU registers
0Bh	Enable CPU cache
0Ch	Initialize caches to initial POST values
0Eh	Initialize I/O component
0Fh	Initialize the local bus IDE
10h	Initialize Power Management
11h	Load alternate registers with initial POST values
12h	Restore CPU control word during warm boot
13h	Reset PCI Bus Mastering devices
14h	Initialize keyboard controller
16h	1-2-2-3 BIOS ROM checksum
17h	Initialize cache before memory Auto size

POST Code	Description
18h	8254 timer initialization
1Ah	8237 DMA controller initialization
1Ch	Reset Programmable Interrupt Controller
20h	1-3-1-1 Test DRAM refresh
22h	1-3-1-3 Test 8742 Keyboard Controller
24h	Set ES segment register to 4 GB
28h	Auto size DRAM
29h	Initialize POST Memory Manager
2Ah	Clear 512 kB base RAM
2Ch	1-3-4-1 RAM failure on address line xxxx*
2Eh	1-3-4-3 RAM failure on data bits xxxx* of low byte of memory bus
2Fh	Enable cache before system BIOS shadow
32h	Test CPU bus-clock frequency
33h	Initialize Phoenix Dispatch Manager
36h	Warm start shut down
38h	Shadow system BIOS ROM
3Ah	Auto size cache
3Ch	Advanced configuration of chipset registers
3Dh	Load alternate registers with CMOS values
41h	Initialize extended memory for RomPilot (optional)
42h	Initialize interrupt vectors
45h	POST device initialization
46h	2-1-2-3 Check ROM copyright notice
48h	Check video configuration against CMOS
49h	Initialize PCI bus and devices
4Ah	Initialize all video adapters in system
4Bh	QuietBoot start (optional)
4Ch	Shadow video BIOS ROM
4Eh	Display BIOS copyright notice
4Fh	Initialize MultiBoot
50h	Display CPU type and speed
51h	Initialize EISA board (optional)
52h	Test keyboard
54h	Set key click if enabled
55h	Enable USB devices
58h	2-2-3-1 Test for unexpected interrupts
59h	Initialize POST display service
5Ah	Display prompt "Press <ESC> to enter SETUP"
5Bh	Disable CPU cache

POST Code	Description
5Ch	Test RAM between 512 and 640 kB
60h	Test extended memory
62h	Test extended memory address lines
64h	Jump to UserPatch1
66h	Configure advanced cache registers
67h	Initialize Multi Processor APIC
68h	Enable external and CPU caches
69h	Setup System Management Mode (SMM) area
6Ah	Display external L2 cache size
6Bh	Load custom defaults (optional)
6Ch	Display shadow-area message
70h	Display error messages
72h	Check for configuration errors
76h	Check for keyboard errors
7Ch	Set up hardware interrupt vectors
7Dh	Initialize Intelligent System Monitoring (optional)
7Eh	Initialize coprocessor if present
80h	Disable onboard Super I/O ports and IRQs (optional)
81h	Late POST device initialization
82h	Detect and install external RS232 ports
83h	Configure non-MCD IDE controllers
84h	Detect and install external parallel ports
85h	Initialize PC-compatible PnP ISA devices
86h	Re-initialize onboard I/O ports.
87h	Configure Motherboard Configurable Devices (optional)
88h	Initialize BIOS Data Area
89h	Enable Non-Maskable Interrupts (NMIs)
8Ah	Initialize Extended BIOS Data Area
8Bh	Test and initialize PS/2 mouse
8Ch	Initialize floppy controller
8Fh	Determine number of ATA drives (optional)
90h	Initialize hard-disk controllers
91h	Initialize local-bus hard-disk controllers
92h	Jump to UserPatch2
93h	Build MPTABLE for multi-processor boards
95h	Install CD ROM for boot
96h	Clear huge ES segment register
97h	Fix up Multi Processor table
98h	1-2 Search for option ROMs and shadow if successful. One long, two short beeps on checksum failure

POST Code	Description
99h	Check for SMART Drive (optional)
9Ch	Set up Power Management
9Dh	Initialize security engine (optional)
9Eh	Enable hardware interrupts
9Fh	Determine number of ATA and SCSI drives
A0h	Set time of day
A2h	Check key lock
A4h	Initialize typematic rate
A8h	Erase <ESC> prompt
AAh	Scan for <ESC> key stroke
ACh	Enter SETUP
AEh	Clear Boot flag
B0h	Check for errors
B1h	Inform RomPilot about the end of POST (optional)
B2h	POST done - prepare to boot operating system
B4h	1 One short beep before boot
B5h	Terminate QuietBoot (optional)
B6h	Check password (optional)
B7h	Initialize ACPI BIOS and PPM Structures
B9h	Prepare Boot
BAh	Initialize SMBIOS
BCh	Clear parity checkers
BDh	Display MultiBoot menu
BEh	Clear screen (optional)
BFh	Check virus and backup reminders
C0h	Try to boot with INT 19
C1h	Initialize POST Error Manager (PEM)
C2h	Initialize error logging
C3h	Initialize error display function
C4h	Initialize system error flags
C6h	Console redirection init.
C7h	Unhook INT 10h if console redirection enabled
C8h	Force check (optional)
C9h	Extended ROM checksum (optional)
CDh	Reclaim console redirection vector

POST Code Description

D2h	Unknown interrupt
D4h	Check Intel Branding string
D8h	Alert Standard Format initialization
D9h	Late init for IPMI
DEh	Log error if micro-code not updated properly

The following are for boot block in Flash ROM**POST Code Description**

E0h	Initialize the chipset
E1h	Initialize the bridge
E2h	Initialize the CPU
E3h	Initialize system timer
E4h	Initialize system I/O
E5h	Check force recovery boot
E6h	Checksum BIOS ROM
E7h	Go to BIOS
E8h	Set Huge Segment
E9h	Initialize Multi Processor
EAh	Initialize OEM special code
EBh	Initialize PIC and DMA
ECh	Initialize Memory type
EDh	Initialize Memory size
EEh	Shadow Boot Block
EFh	System memory test
F0h	Initialize interrupt vectors
F1h	Initialize Run Time Clock
F2h	Initialize video
F3h	Initialize System Management Manager
F4h	Output one beep
F5h	Clear Huge Segment
F6h	Boot to Mini DOS
F7h	Boot to Full DOS

*If the BIOS detects errors on 2C, 2E, or 30 (base 512K RAM error), it displays an additional word-bitmap (**xxxx**) indicating the address line or bits that have failed. For example, "2C 0002" means address line 1 (bit one set) has failed. "2E 1020" means data bits 12 and 5 (bits 12 and 5 set) have failed in the lower 16 bits. The BIOS also sends the bitmap to the port-80 LED display. It first displays the checkpoint code, followed by a delay, the high-order byte, another delay, and then the low-order byte of the error. It repeats this sequence continuously.

Notes

Appendix C

Intel HostRAID Setup Guidelines

After all the hardware has been installed, you must first configure Intel's ESB2 SATA RAID* before you install the Windows Operating System and other software drivers.

Important Notes to the User:

Note 1: If you do not wish to configure onboard SATA RAID functions, please go directly to Section C-2 for Operating System & Other Software Installation.

Note 2: This chapter describes RAID Configuration Instructions for the Intel ESB2 RAID Controller designed for the Windows OS.

C-1 Introduction to Serial ATA and Parallel ATA

To configure the SATA RAID functions, you must first use the Intel ESB2 SATA RAID Utility program to configure the RAID Level that you desire before installing the Windows XP/2000/2003 operating system and other software drivers. (The necessary drivers are all included on the Supermicro CD that came packaged with your motherboard.) Note that the current version of the ESB2 SATA RAID Utility can only support Windows XP/2000/2003 Operating Systems.

Serial ATA (SATA)

Serial ATA (SATA) is a physical storage interface that uses a single cable with a minimum of four wires to create a point-to-point connection between devices. It is a serial link, which supports transfer rates up to 3.0 Gbps. Because the serial cables used in SATA are thinner than the traditional cables used in Parallel ATA (PATA), SATA systems have better airflow and can be installed in smaller chassis than Parallel ATA. In addition, the cables used in PATA are limited to a length of 40cm, while Serial ATA cables can be up to one meter in length. Overall, SATA provides better functionality than PATA.

Introduction to the Intel ESB2 Serial RAID

Located in the South Bridge of the 5000P (Blackford) chipset, the I/O Controller Hub (ESB2) provides the I/O subsystem with access to the rest of the system. It supports an 1-channel UltraATA/100 Bus Master IDE controller (PATA) and six Serial ATA (SATA) ports. The ESB2 supports the following PATA and SATA device configurations: Legacy mode and Native mode.

The Intel HostRAID Configurations

The following types of Intel's HostRAID configurations are supported:

RAID 0 (Data Striping): this writes data in parallel, interleaved ("striped") sections of two hard drives. Data transfer rate is doubled over using a single disk.

RAID1 (Data Mirroring): an identical data image from one drive is copied to another drive. The second drive must be the same size or larger than the first drive.

RAID 10 (Striping & Mirroring): RAID 0 and 1 schemes are combined (without parity information) to get the benefits of both.

RAID 5: both data and parity information are striped and mirrored across three or more hard drives.

The Intel Matrix Storage

The Intel Matrix Storage, supported by the ESB2, allows the user to create RAID 0, RAID 1, RAID 10 and RAID 5 sets by using only six identical hard disk drives. The Intel Matrix Storage Technology creates two partitions on each hard disk drive and generate a virtual RAID 0, RAID 1, RAID 10 and RAID 5 sets. It also allows you the change the HDD partition size without any data.

Configuring BIOS settings for SATA RAID Functions (Native Mode)

1. Press the key during system bootup to enter the BIOS Setup Utility.

Note: If it is the first time powering on the system, we recommend you load the Optimized Default Settings. If you have already done so, please skip to Step 3.

2. Use the arrow keys to select the "Exit" Settings. Once in the "Exit" settings, Scroll down to select "Load Optimized Default Settings" and press the <Enter> key. Select "OK" to confirm the selection. Press the <Enter> key to load the default settings for the BIOS.

3. Use the arrow keys to select the "Main" section in BIOS.

4. Scroll down to "SATA Controller Mode" and press the <Enter> key to select "Enhanced"

5. Scroll down to "SATA RAID Enabled" and press <Enter>. Then, select "Enabled."

6. Go to "Exit." Select "Exit Saving Changes" from the "Exit" menu. Press the <Enter> key to save the changes and exit the BIOS.

7. Once you've exited the BIOS Utility, the system will re-boot.

8. During the system boot-up, press the <Ctrl> and <I> keys simultaneously to run the Intel RAID Configuration Utility when prompted by the following message: *Press <Ctrl> <I> for the Intel RAID Configuration Utility.*

(Note: The Intel RAID Configuration Utility is only available for systems with two or more drives installed. The Intel RAID Utility screen will not display in systems with one drive installed.)

Using the Intel ESB2 SATA RAID Utility Program

1. Creating, Deleting and Resetting RAID Volumes:

- a. After the system exits from the BIOS Setup Utility, the system will automatically reboot. The following screen appears after Power-On Self Test.

```

RAID Volumes:
None defined.

Physical Disks:
Port Drive Model      Serial #              Size   Type/Status(Vol ID)
0    WDC WD2500SD-01K  WD-WMAL72034971      232.9GB Non-RAID Disk
1    WDC WD2500SD-01K  WD-WMAL72034599      232.9GB Non-RAID Disk
2    WDC WD2500JD-00F  WD-WMAEH1376109      232.9GB Non-RAID Disk
3    WDC WD2500JD-00F  WD-WMAEH1449527      232.9GB Non-RAID Disk

Press <CTRL-I> to enter Configuration Utility...

Adaptec SCSI BIOS v4.30.0
Copyright 2003 Adaptec, Inc. All Rights Reserved.

<<< Press <Ctrl><A> for SCSISelect(TM) Utility! >>>

Slot Ch ID LUN Vendor      Product              Size Bus Status
-----
04  A  10  0

```

- b. When you see the above screen, press the <Ctrl> and the <I> keys simultaneously to have the main menu of the SATA RAID Utility appear:

(Note: All graphics and screen shots shown in the manual are for reference only. The screen shots shown in the manual do not imply Supernicro's endorsement or non-endorsement on any 3rd party's product. Your screens may or many not look exactly the same as the graphics shown in this manual.)

Creating a RAID 0 Volume:

- a. Select "Create RAID Volume" from the main menu and press the <Enter> key. The following screen will appear:



- b. Specify a name for the RAID 0 set and press the <Tab> key or the <Enter> key to go to the next field. (You can use the <Esc> key to select the previous menu.)
- c. When RAID Level item is highlighted, press the <Up Arrow>, <Down Arrow> keys to select RAID 0 (Stripe) and hit <Enter>.
- d. When the Disks item is highlighted, press <Enter> to select the HDD to configure as RAID. The following pop-up screen (*See the Note on Page C-3) displays:

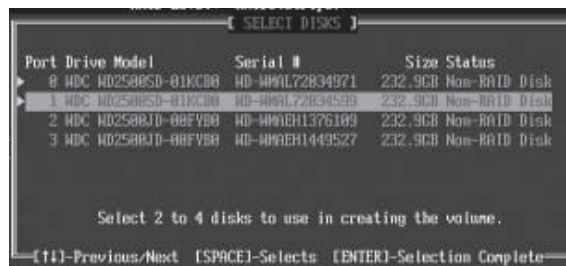

- e. Use the <Up Arrow>, <Down Arrow> keys to highlight a drive and press <Space> to select it. A triangle appears to confirm the selection of the drive.
- f. Use the <Up Arrow>, <Down Arrow> keys to select the stripe size, ranging from 4 KB to 128 KB for the RAID 0 array, and hit <Enter>. (**Note:** For a server, please use a lower stripe size, and for a multimedia system, use a higher stripe size. The default stripe size is 128 KB.)
- g. Press <Enter> when the Create Volume item is highlighted. A warning message displays.
- h. When asked "Are you sure you want to create this volume (Y/N), press "Y" to create the RAID volume, or type "N" to go back to the Create Volume menu.

Creating a RAID 1 Volume:

- a. Select "Create RAID Volume" from the main menu and press the <Enter> key. The following screen will appear:

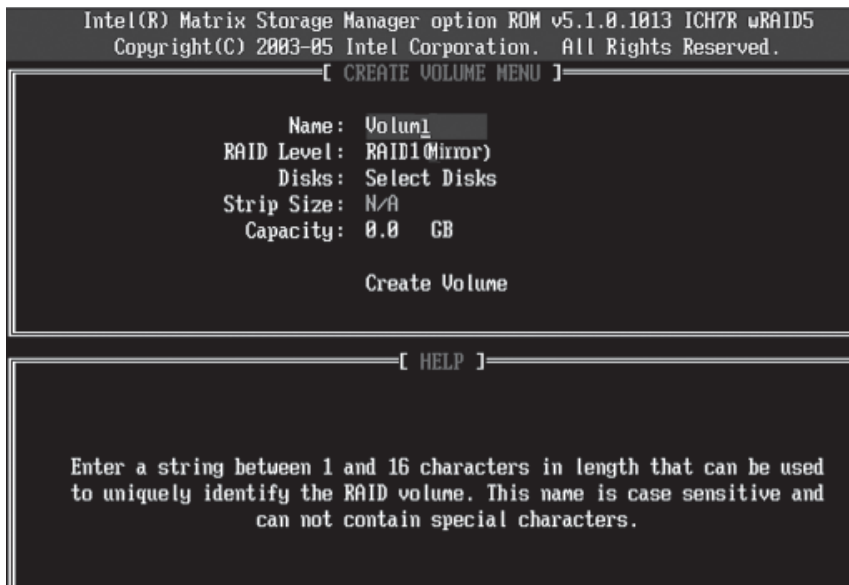

- b. Specify a name for the RAID 1 set and press the <Tab> key or the <Enter> key to go to the next field. (You can use the <Esc> key to select the previous menu.)
- c. When RAID Level item is highlighted, press the <Up Arrow>, <Down Arrow> keys to select RAID 1 (Mirror) and hit <Enter>.
- d. When the Capacity item is highlighted, enter your RAID volume capacity and hit <Enter>. The default setting is the maximum capacity allowed.
- e. Press <Enter> when the Create Volume item is highlighted. A warning message displays.
- f. When asked "Are you sure you want to create this volume (Y/N)", press "Y" to create the RAID volume, or type "N" to go back to the Create Volume menu.

Creating a RAID 10 (RAID 1+ RAID 0):

- a. Select "Create RAID Volume" from the main menu and press the <Enter> key. The following screen will appear:

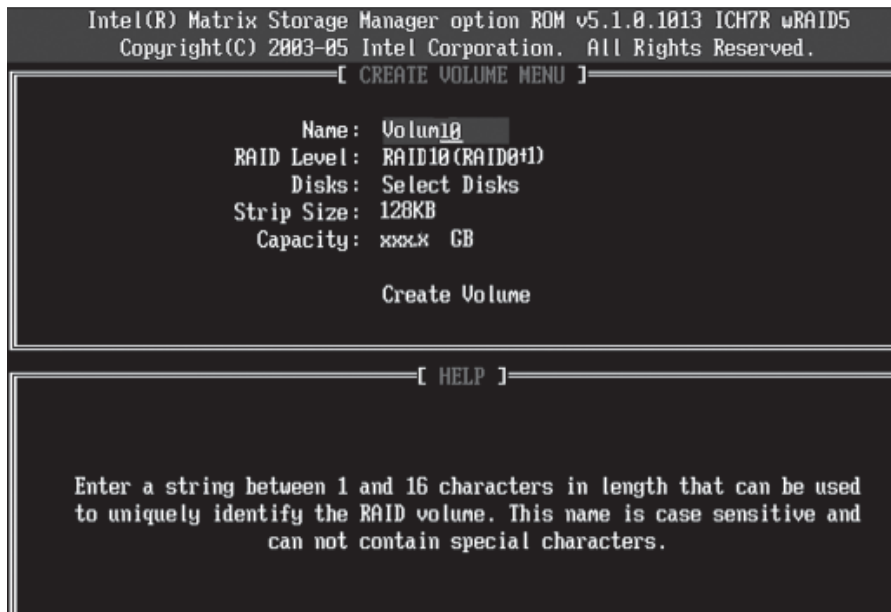

- b. Specify a name for the RAID 10 set and press <Enter>.
- c. When RAID Level item is highlighted, use the <Up Arrow>, <Down Arrow> keys to select RAID 10 (RAID1 + RAID0) and hit <Enter>.
- d. When the Stripe Size is highlighted, use the <Up Arrow>, <Down Arrow> keys to select the stripe size from 4 KB to 128 KB for your RAID 10 and hit <Enter>. The default setting is 64 KB. (**Note:** For a server, please use a lower stripe size, and for a multimedia system, use a higher stripe size.)
- e. When the RAID Volume Capacity item is highlighted, enter your RAID volume capacity and hit <Enter>. The default setting is the maximum capacity allowed.
- f. Press <Enter> when the Create Volume item is highlighted. A warning message displays.
- g. When asked "Are you sure you want to create this volume (Y/N)", press "Y" to create the RAID volume, or type "N" to go back to the Create Volume menu.

Creating a RAID 5 Set (Parity):

- a. Select "Create RAID Volume" from the main menu and press the <Enter> key. The following screen will appear:



- b. Specify a name for the RAID 5 set and press <Enter>.
- c. When the Raid Level is highlighted, use the <Up Arrow>, <Down Arrow> keys to select RAID 5 (Parity) and hit <Enter>.
- d. When the Disk item is highlighted, press <Enter> to select the HDD to configure as RAID. The following pop-up screen (*See the Note on Page C-3) displays:

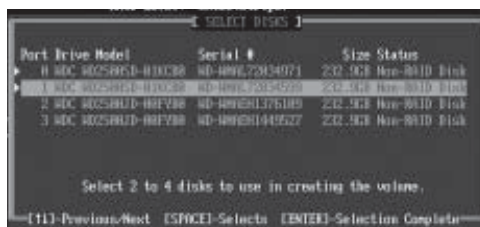

- e. Use the <Up Arrow>, <Down Arrow> keys to highlight a drive and press <Space> to select it. A triangle appears to confirm the selection of the drive.
- f. Use the <Up Arrow>, <Down Arrow> keys to select the stripe size, ranging from 4 KB to 128 KB for the RAID 5 array, and hit <Enter>. (**Note:** For a server, please use a lower stripe size, and for a multimedia system, use a higher stripe size. The default stripe size is 128 KB.)
- g. Enter your desired RAID volume capacity and press <Enter> when the capacity item is highlighted. The default setting is the maximum capacity allowed.
- h. Press Enter when the Create Volume item is highlighted. A warning message displays.
- i. When asked "Are you sure you want to create this volume (Y/N)", press "Y" to create the RAID volume, or type "N" to go back to the Create Volume menu.

Deleting RAID Volume:



(Warning: Be sure to back up your data before deleting a RAID set. You will lose all data on the disk drives when deleting a RAID set.)

- a. From the main menu, select item2-Delete RAID Volume, and press <Enter>.
- b. Use the <Up Arrow>, <Down Arrow> keys to select the RAID set you want to delete and press . A Warning message displays.
- c. When asked "Are you sure you want to delete this volume (Y/N), press "Y" to delete the RAID volume, or type "N" to go back to the Delete Volume menu.

Resetting to Non-RAID and Resetting a RAID HDD

(Warning: Be cautious when you reset a RAID volume HDD to non-RAID or Resetting a RAID HDD. Resetting a RAID volume HDD or Resetting a RAID HDD will reformat the HDD and delete the internal RAID structure on the drive.)

- a. From the main menu, select item3-Reset Disks to Non- RAID, and press <Enter>. The following screen will appear:

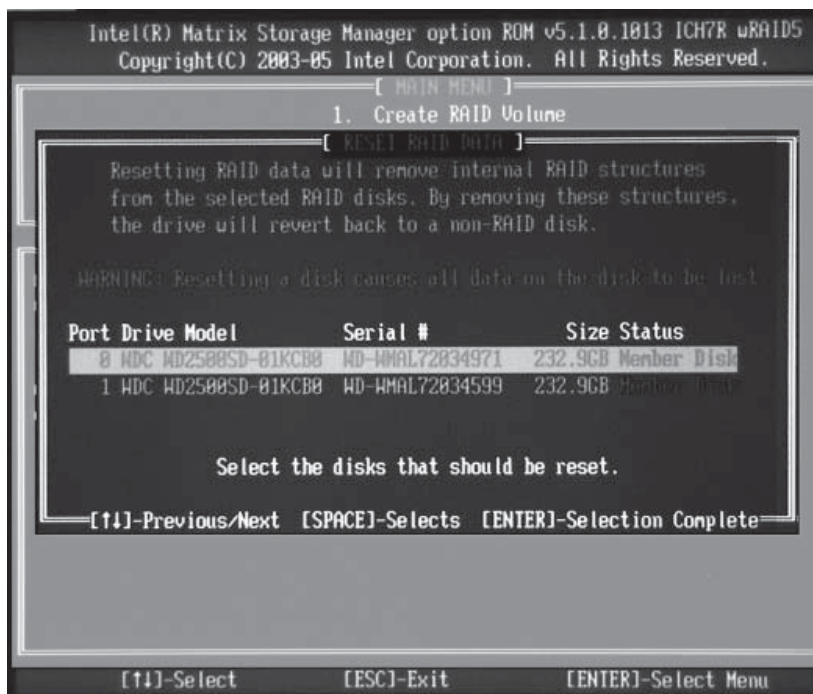

- b. Use the <Up Arrow>, <Down Arrow> keys to highlight the RAID set drive to reset and press <Space> to select.
- c. Press <Enter> to reset the RAID set drive. A Warning message displays.
- d. Press "Y" to reset the drive, or type "N" to go back to the main menu.

Exiting the Intel Matrix Storage Manager Utility:

- a. From the main menu, select item4-Exit, and press <Enter>. A warning message will appear.
- b. Press "Y" to reset the drive, or type "N" to go back to the main menu.

C-2 Installing the Windows XP/2000/2003 for systems with RAID Functions

Installing a New Operating System-the Windows XP/2000/2003 OS

- a. Insert the Microsoft Windows XP/2000/2003 Setup CD in the CD Driver, and the system will start booting up from CD.
- b. Press the <F6> key when the message-" Press F6 if you need to install a third party SCSI or RAID driver" displays.
- c. When the Windows XP/2000/2003 Setup screen appears, press "S" to specify additional device(s).
- d. Insert the driver diskette-"Intel AA RAID XP/2000/2003 Driver for ESB2 into Drive A: and press the <Enter> key.
- e. Choose the Intel(R) ESB2 *SATA RAID Controller* from the list indicated in the XP/2000/2003 Setup Screen, and press the <Enter> key.
- f. Press the <Enter> key to continue the installation process. (If you need to specify any additional devices to be installed, do it at this time.) Once all devices are specified, press the <Enter> key to continue with the installation.
- g. From the Windows XP/2000/2003 Setup screen, press the <Enter> key. The XP/2000/2003 Setup will automatically load all device files and then, continue the Windows XP/2000/2003 installation.
- h. After Windows XP/2000/2003 Installation is completed, the system will automatically reboot.

(**Note:** the current version of the ESB2 SATA RAID Utility can only support the Windows XP/2000/2003 Operating System.)

Appendix D

Adaptec HostRAID Setup Guidelines

After all the hardware has been installed, you must first configure the Adaptec Embedded Serial ATA RAID before you install the Windows operating system. The necessary drivers are all included on the Supermicro bootable CDs that came packaged with your motherboard. **Note:** The following section provides information on the Adaptec SATA RAID Driver based on the Intel Enterprise South Bridge 2 (ESB2) Controller.

D-1 Introduction to the Adaptec Embedded Serial ATA RAID Controller Driver

Serial ATA (SATA)

Serial ATA(SATA) is a physical storage interface. It uses a single cable with a minimum of four wires to create a point-to-point connection between devices. It is a serial link which supports SATA Transfer rates up to 3.0 Gbps. Because the serial cables used in SATA are thinner than the traditional cables used in Parallel ATA(PATA), SATA systems have better airflow and can be installed in smaller chassis than Parallel ATA. In addition, the cables used in PATA can only extend to 40cm long, while Serial ATA cables can extend up to one meter. Overall, Serial ATA provides better functionality than Parallel ATA.

Introduction to the Intel ESB2 I/O Controller Hub

Located in the South Bridge of the Intel 5000P (Blackford) Chipset, the ESB2 I/O Controller Hub provides the I/O subsystem with access to the rest of the system. It supports 1-channel Ultra ATA/100 Bus Master IDE controller (PATA) and one Adaptec's Serial ATA (SATA) Host Controller, which support up to six Serial ATA drives, up to two RAID volumes and up to four drives in RAID Configurations. (See the table below for details.)

* Adaptec's SATA HostRAID Controller Firmware supports:	
Drives supported	Six
Number of RAID Volumes supported	Two
Total Drives in RAID Configurations	Four
Examples of Valid RAID Configurations:	
Two drives of RAID 1 + two drives of RAID 0	
Two drives of RAID 1 + two drives of RAID 1	
Three drives of RAID 0	
Four drives of RAID 0	
Examples of Invalid RAID Configurations:	
Three drives of RAID 0 + two drives of RAID 1	
(*Note: this table is applicable to Adaptec's HostRAID Controller Firmware only.)	

To configure the Adaptec SATA RAID for Operating Systems that support RAID functions(--Windows, Red Hat & SuSe, Linux)

1. Press the key during system bootup to enter the BIOS Setup Utility.

Note: If it is the first time powering on the system, we recommend you load the Optimized Default Settings. If you have already done so, please skip to Step 3.

2. Use the arrow keys to select the "Exit" Settings. Once in the "Exit" settings, Scroll down to select "Load Optimized Default Settings" and press the <Enter> key. Select "OK" to confirm the selection. Press the <Enter> key to load the default settings for the BIOS.

3. Use the arrow keys to select the "Main" section in BIOS.

4. Scroll down to "SATA Control Mode" and press the <Enter> key to select "Enhanced"

5. Scroll down to "SATA RAID Enabled" and press <Enter>. Then, select "Enabled."

6. Scroll down to "ICH RAID Codebase" and select "Adaptec". Then press <Enter>. (*For ICH RAID Codebase: Change the setting from Intel to Adaptec.)

7. Go to "Exit". Select "Exit Saving Changes" from the "Exit" menu. Press the <Enter> key to save the changes and exit the BIOS.

8. Once you've exited the BIOS Utility, the system will re-boot.

9. During the system boot-up, press the <Ctrl> and <A> keys simultaneously to run the Intel RAID Configuration Utility when prompted by the following message: *Press <Ctrl> <A> for Intel RAID Configuration Utility.*

The Adaptec Embedded Serial ATA with HostRAID Controller Driver

The Adaptec Embedded Serial ATA RAID Controller adds SATA/RAID functionality and performance enhancements to a motherboard. RAID striping (RAID 0) allows data to be written across multiple drives, greatly improving hard disk I/O performance. RAID mirroring (RAID 1) allows data to be simultaneously written to two drives, improving data security even if a single hard disk fails. A Stripe of Mirrors (RAID 10) provides multiple RAID 1 mirrors and a RAID 0 stripe, maximizing data security and system efficiency. By incorporating the Adaptec Embedded Serial ATA into the motherboard design, Supermicro's X7DB8/X7DBE offers the user the benefits of SATARAID without the high costs associated with hardware RAID applications.

Using the Adaptec RAID Configuration Utility (ARC)

The Adaptec RAID Configuration Utility, an embedded BIOS Utility, includes the following:

*Array Configuration Utility: Use this utility to create, configure and manage arrays.

* Disk Utilities: Use this option to format or verify disks.

To run the Adaptec RAID Configuration Utility, you will need to do the following:

1. Enable RAID functions in the system BIOS (refer to Chapter 4 for System BIOS Configurations).
2. Press the <Ctrl> and <A> keys simultaneously when prompted to do so during system boot. (Refer to the previous page for detailed instructions.)

A. Using the Array Configuration Utility (ACU)

When you press <Ctrl> and <A> keys simultaneously at the prompt during system bootup, the main menu will appear.

(Note: To select an option, use the arrow keys to highlight the item and then press the <Enter> key to select it. To return to the previous menu, press the <ESC> key. Press the <Insert> key to select a drive. When a drive is highlighted (selected), press the <Delete> key to de-select it.)

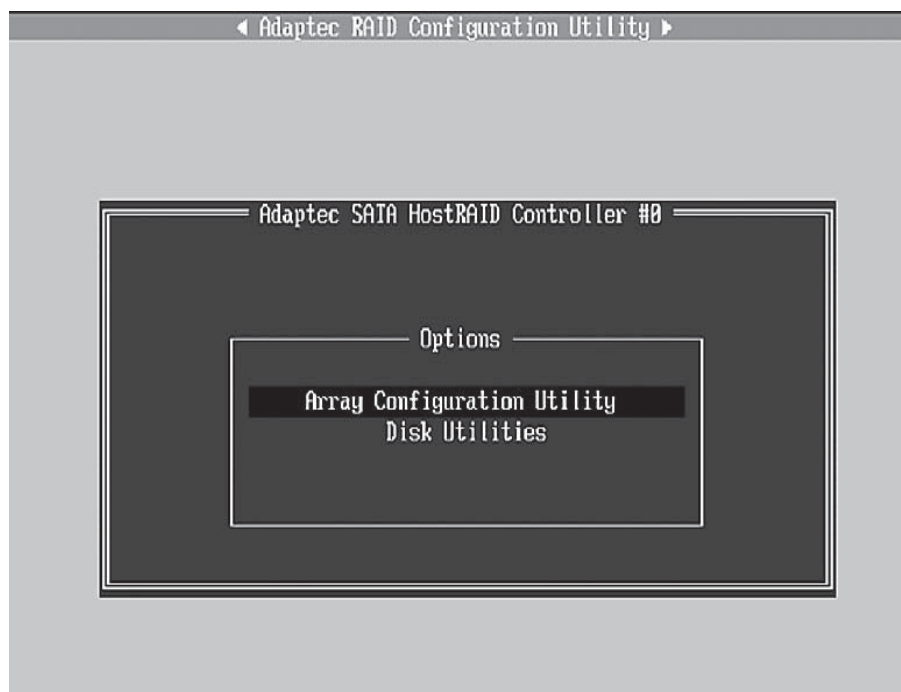

Managing Arrays

Select this option to view array properties, and configure array settings.

To select this option, using the arrow keys and the <enter> key, select "Managing Arrays" from the main menu as shown above.

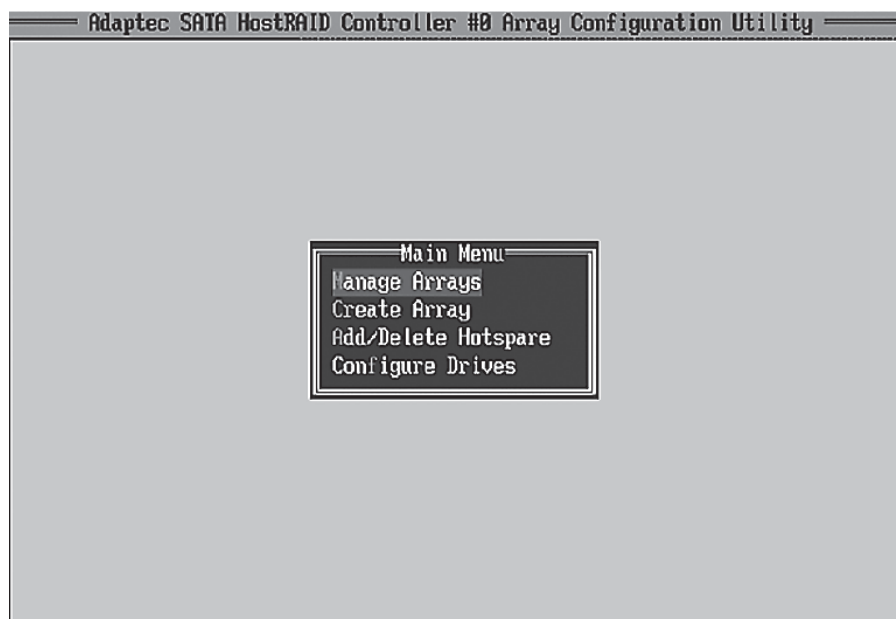

Configuring Disk Drives

You may need to configure a disk drive before you can use it.

Caution: Configuring a disk may overwrite the partition table on the disk and may make any data on the disk inaccessible. If the drive is used in an array, you may not be able to use the array again.

Do not configure a disk that is part of a boot array. To determine which disks are associated with a particular array, please refer to [Viewing Array Properties](#).

To configure a disk drive:

1. From the main menu (shown on Page D-4), select Configure Drives and hit <Enter> (as shown below.)



2. From the "Select Drives for Configuring" List (shown below,) select the drives you want to configure and press <Insert>.

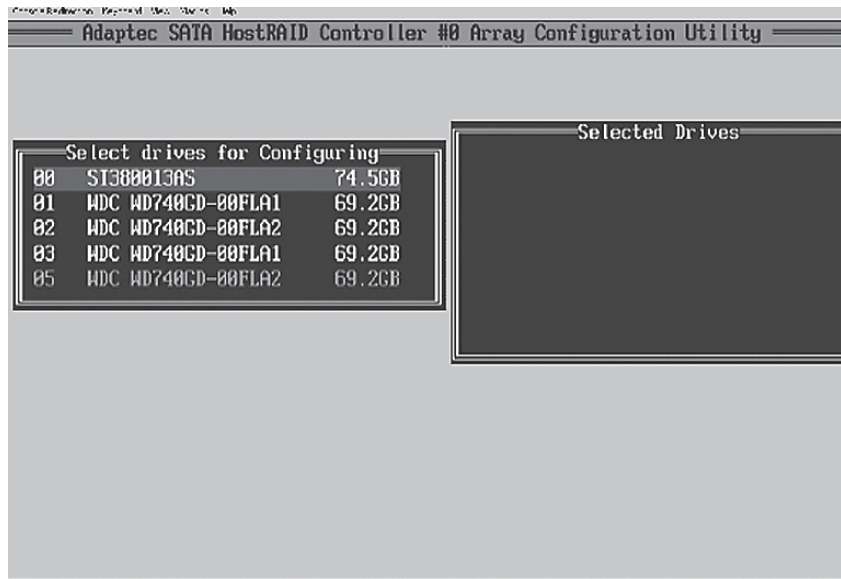

3. The drive you've selected will appear in the "Selected Drives Dialog Box" on the right (as shown below.) Repeat the same steps until all drives that you want to configure appear in the selected drives box.

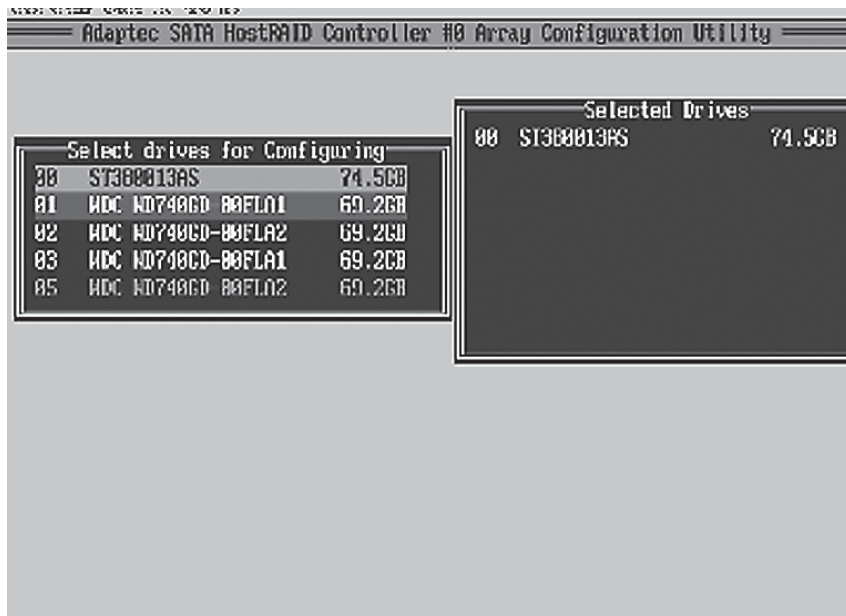

4. Once both drives display in the selected drive box, press <Enter.>

5. Read the warning message as shown in the screen below.

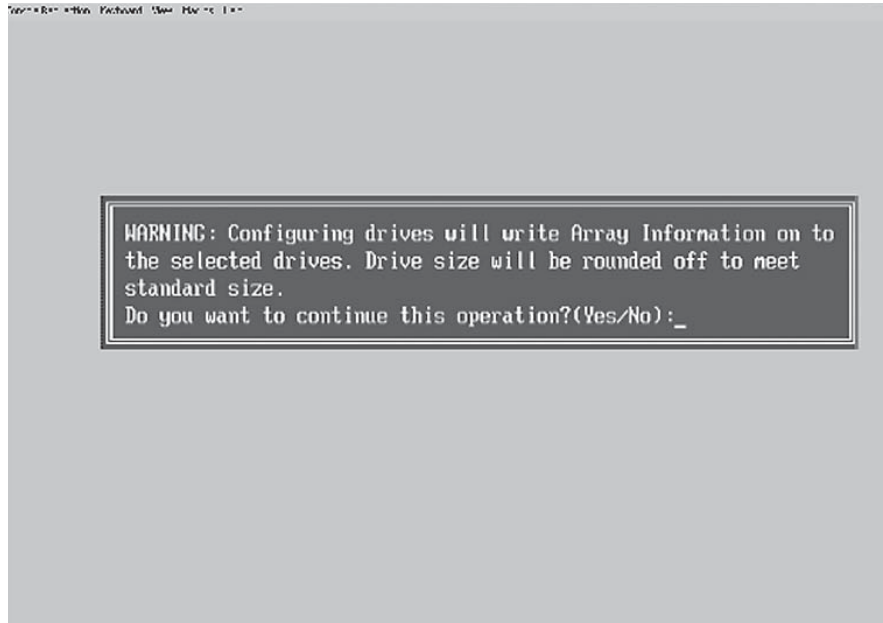

6. Make sure that you have selected the correct disk drives to configure. If correct, type Y to continue.

Creating Arrays

Before you create arrays, make sure that the disks for the array are connected and installed in your system. Note that disks with no usable space, or disks that are un-initialized or not formatted are shown in gray and cannot be used. (**Note:** It is recommended that you configure devices before you create arrays.)

To create an array:

1. From the main menu (shown on page D-4), select Create Array.
2. Select the disks for the new array and press Insert (as the screen shown below). (**Note:** To de-select any disk, highlight the disk and press Delete.)

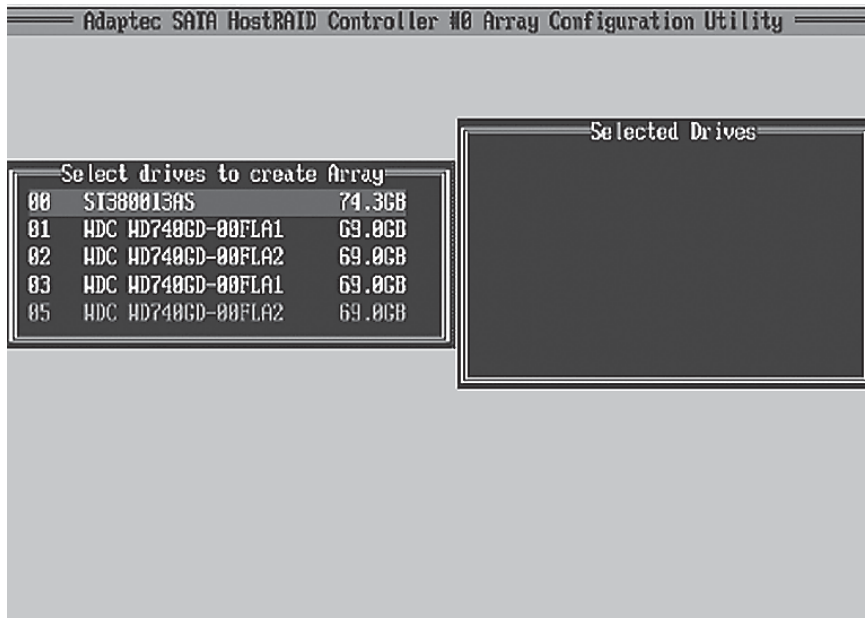

3. The arrays you have selected will appear on the Selected Drives dialog box on the right (as shown below.)

4. Press Enter when both disks for the new array are selected. The Array Properties menu displays.

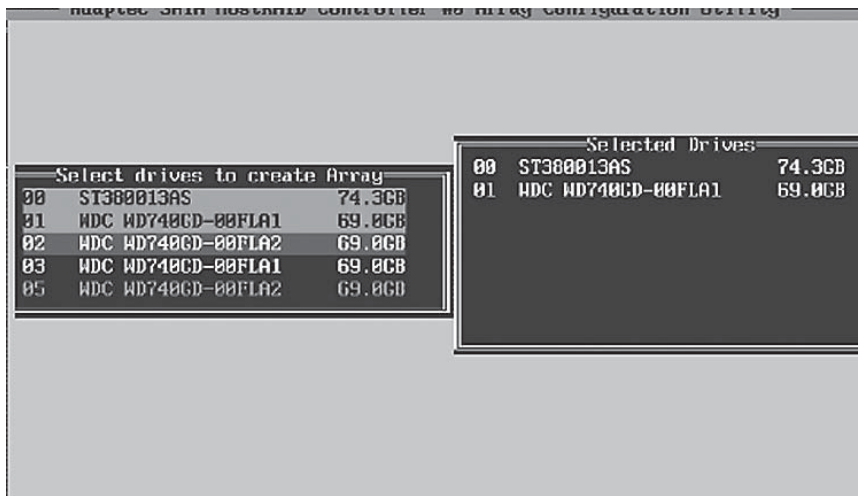

Assigning Array Properties

Once a new array is completed, you can assign properties to the array.

***Caution:** Once the array is created and its properties are assigned, and you cannot change the array properties using this utility.

To assign properties to the new array:

1. In the Array Properties menu (as shown in the screen below), select an array type and press Enter. Only the available array types will be displayed on the screen. (RAID 0 or RAID 1 requires two drives.)

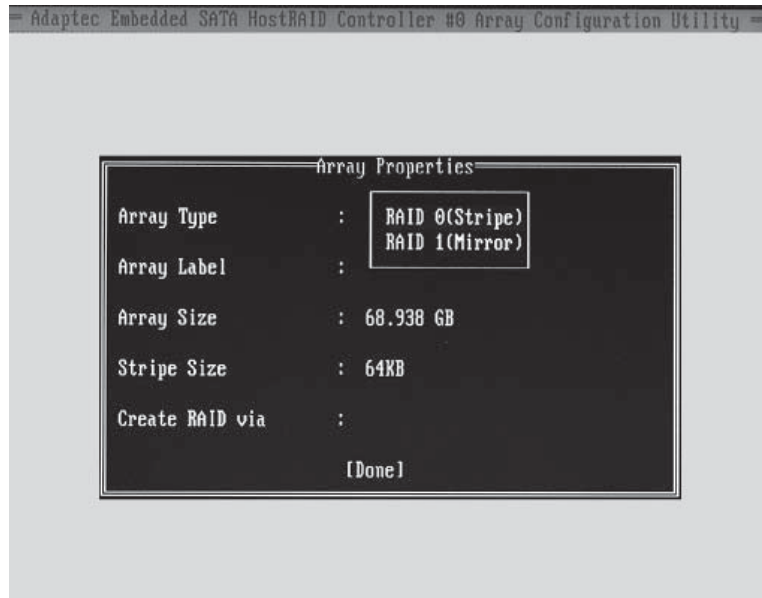

2. Under the item "Array Label", type in a label and press <Enter>. (**Note:** The label shall not be more than 15 characters.)
3. For RAID 0, select the desired stripe size. (**Note:** Available stripe sizes are 16, 32, and 64 KB. 64K is default. Please do not change the default setting.)
4. The item: "Create RAID via" allows you to select between the different ways of creating methods for RAID 0 and RAID 1.

The following table gives examples of when each is appropriate.

D 0	Quick Init	Creating a RAID 0 on new drives
D 0	Migrate*	Creating a RAID 0 from one new drive and one drive with data you wish to preserve
D 1	Build*	Any time you wish to create a RAID 1, but especially if you have data on one drive that you wish to preserve
D 1, D 10	Clear	Creating a RAID 1 or RAID 10 on new drives, or when you want to ensure that the array contains no data after creation.
D 1, D 10	Quick Init	Fastest way to create a RAID 1 or RAID 10 Appropriate when using new drives

Note: If you select Migrate for RAID 0, or Build for RAID 1, you will be asked to select the source drive. The contents of the source drive will be preserved. However, the data on the new drive will be lost.

- When you are finished, press <Done> (as the screen shown below).

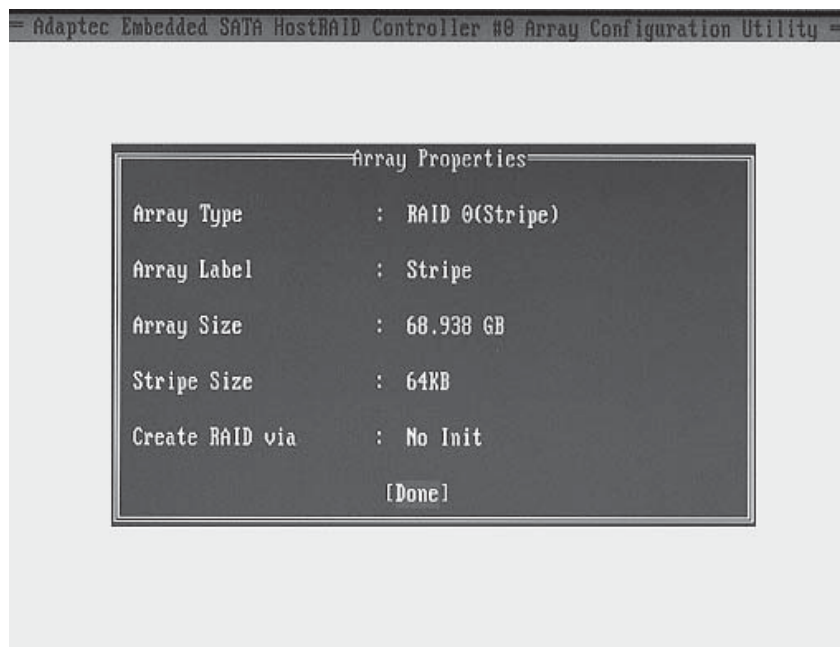

Notes:

- Before adding a new drive to an array, be sure to back up any data stored on the new drive; otherwise, all data will be lost.
- If you stop the Build or Clear process on a RAID 1, you can restart it by pressing <Ctrl> and <R>.
- If you've used the Quick Init option to create a RAID1, it may return some data mis-comparison when you run a consistency check at a later time. This is normal.
- The Adaptec Host RAID allows you to use drives of different sizes in a RAID. However, you can only select a smaller drive as the source or first drive during a build operation.
- When migrating from single volume to RAID 0, migrating from a larger drive to a smaller drive is allowed. However, the destination drive must be at least half the capacity of the source drive.
- It is not recommended that you migrate or build an array on Windows dynamic disks (volumes) because it will result in data loss.

Warning: Do not interrupt the process when you create a RAID 0 using the Migrate option. If you do, you will not be able to restart the system, or to recover the data that was on the source drive.

Adding a Bootable Array

To make an array bootable:

1. From the Main menu, select Manage Arrays.
2. From the List of Arrays, select the array you want to make bootable, and press <Ctrl> and .
3. Enter Y to create a bootable array when the following message is displayed: "This will make all other existing bootable array non-bootable. Do you want to make this array bootable? (Yes/No):" Then, a bootable array will be created. An asterisk (*) will appear next to the bootable array (as shown in the picture below:)

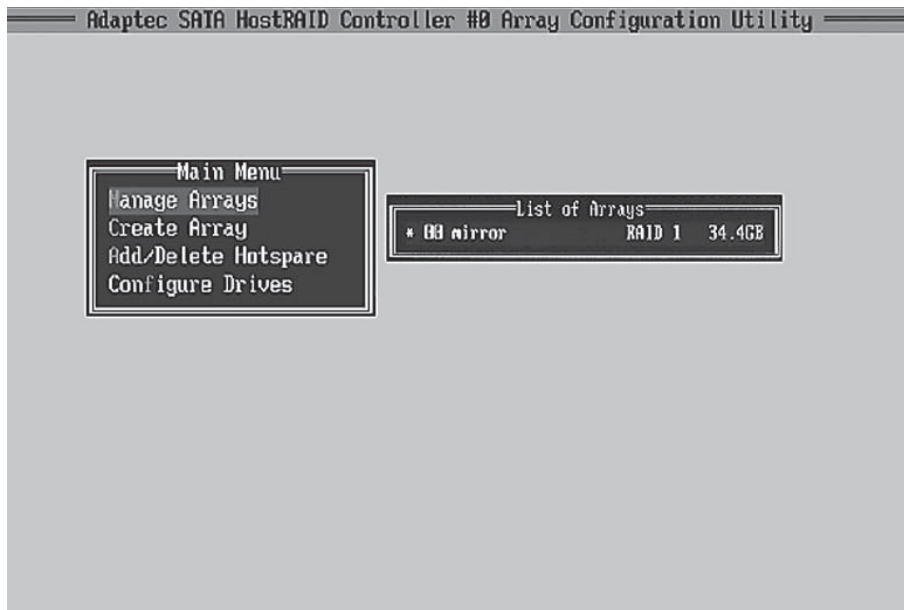

Deleting a Bootable Array

To delete a bootable array:

1. From the Main menu, select Manage Arrays.
2. From the List of Arrays, select the bootable array you want to delete, and press <Ctrl> and . Note: a bootable array is the array marked with an asterisk * (as shown in the picture above.)
3. When the following message is displayed: "The array is already marked bootable. Do you want to make this array as not bootable? (Yes/No)," Enter Y to delete a bootable array. The bootable array will be deleted and the asterisk will disappear.

(Note: Do not use the delete key to delete the bootable array.)

Adding/Deleting Hotspares

To add a Hotspare:

(Note: In order to rebuild a RAID (RAID 0 or RAID 1), you would need to add a new HDD as a hotspare.)

1. From the main menu (shown on Page D-4), select Add/Delete Hotspares.
2. Use the up and down arrow keys to highlight and select the disk you want to designate as a hotspare, and press <Insert>, and then, press <Enter>.
3. Press Yes when the following prompt is displayed:

"Do you want to create spare?" (Yes/No?)

The spare you have selected will appear in the Selected drives Menu.

To delete a Hotspare:

1. From the main menu (shown on Page D-4), select Add/Delete Hotspares.
2. Use the up and down arrow keys to highlight and select the Hotspare you want to delete, and press <delete>, and then, press <Enter>.
3. When the following warning is displayed: "Do you want to delete the hot spare?" (Yes/No?), press Yes to delete the hotspare you have selected.

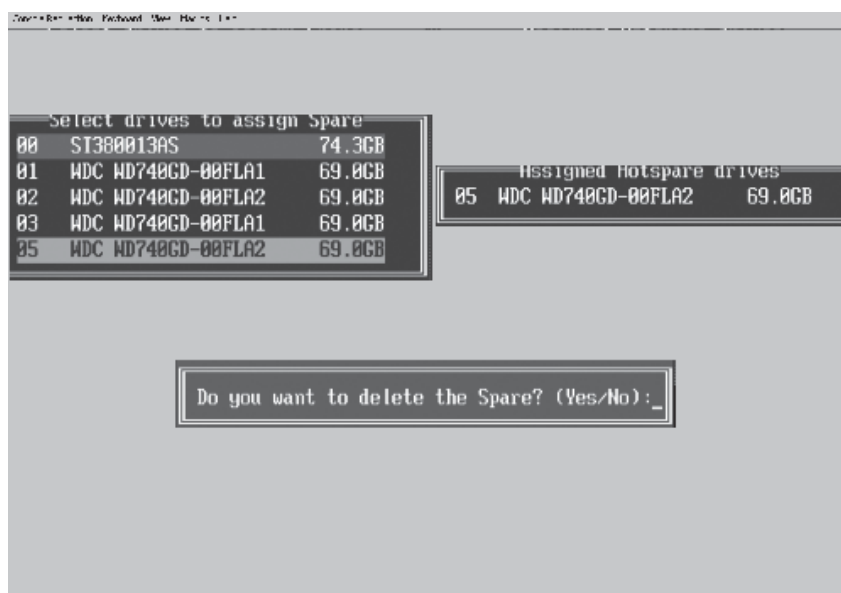

Viewing Array Properties

To view the properties of an existing array:

1. From the main menu, select Manage Arrays and hit <Enter> (as shown on the previous page.)
2. From the List of Arrays dialog box (shown below), select the array you want to view and press Enter.

The Array Properties dialog box appears (as shown below), showing detailed information on the array. The physical disks associated with the array are displayed here.

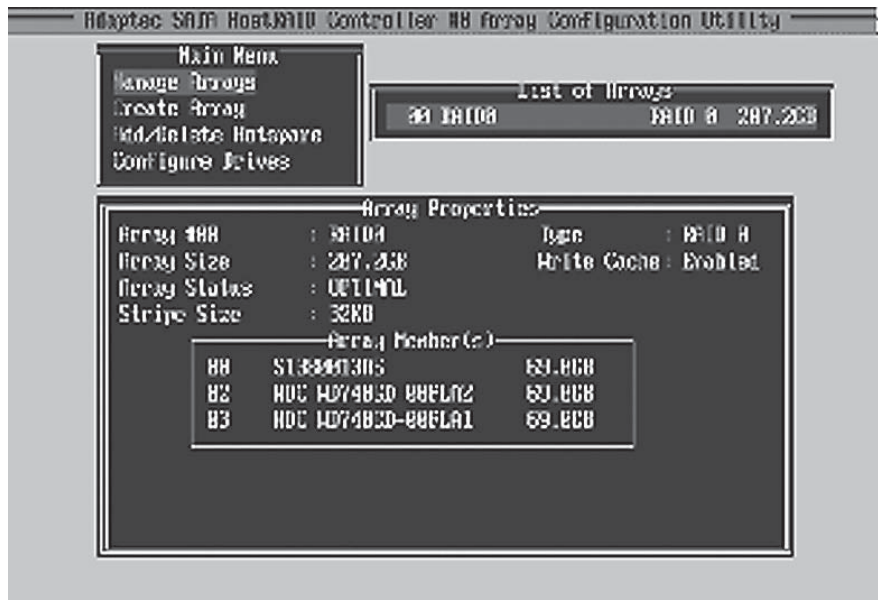

3. Press Esc to return to the previous menu.

Rebuilding Arrays

Note 1: Rebuilding applies to Fault Tolerant array (RAID 1) only.

If an array building process is interrupted or when one critical member is missing, you must perform a Rebuild to restore its functionality. For a critical array rebuilding operation, the optimal drive is the source drive.

Note 2: If no spare array exists and a hard disk drive fails, you need to create a spare before you can rebuild an array.

To Rebuild an array:

1 From the Main Menu, select Manage Arrays (as shown in the screen below). From the List of Arrays, select the array you want to rebuild.

2 Press <Ctrl> and <R> to rebuild.

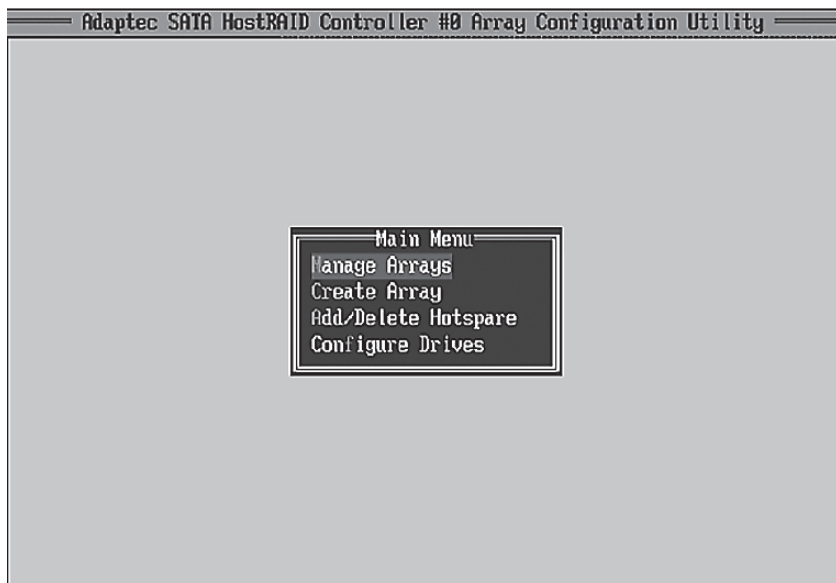

Deleting Arrays

***Warning:** Back up the data on an array before you delete it to prevent data loss. Deleted arrays cannot be restored.

To delete an existing array:

1. From the main menu (shown on Page D-4), select Manage Arrays.
2. Select the array you wish to delete and press <delete>.
3. In the Array Properties dialog box, select Delete and press <Enter>. The following prompt is displayed:

Warning!! Deleting the array will render array unusable. Do you want to delete the array? (Yes/No):

RAID 1 only—the following prompt is also displayed:

Deleting the partition will result in data loss! Do you also want to delete the partition? (Yes/No):

4. Press Yes to delete the array and partition or No to return to the previous menu.
5. Press Esc to return to the previous menu.

Using the Disk Utilities

The Disk Utilities enable you to format or verify the media of your Serial ATA hard disks.

To access the disk utilities:



1. From the Adaptec RAID Configuration Utility Menu, select Disk Utilities (as shown above) and press <Enter>. The following screen appears.

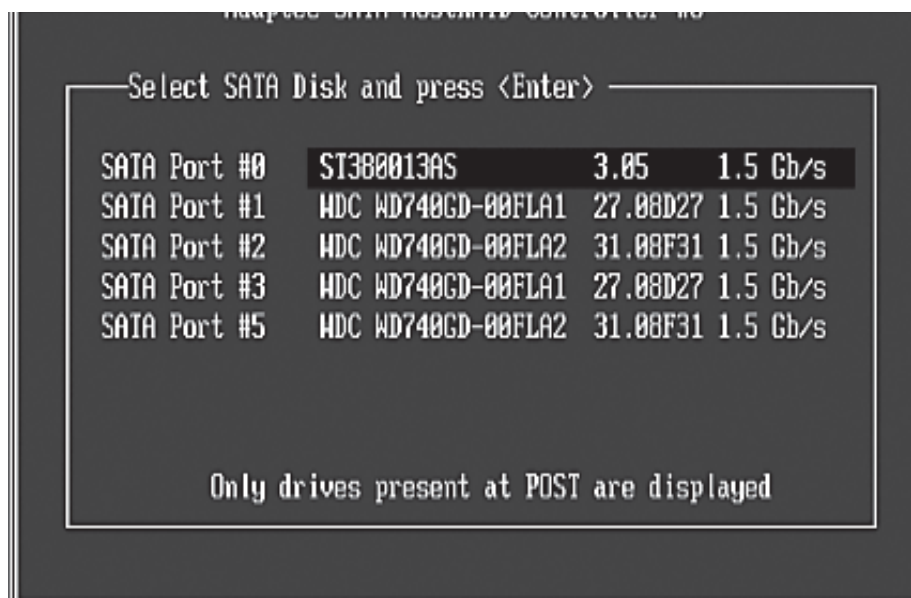

2. Select the desired disk and press <Enter>. The following screen appears:

To format a disk:

Note: The operation of Formatting Disk allows you to perform a low-level formatting of a hard drive by writing zeros to the entire disk. Serial ATA drives are low-level formatted at the factory and do not need to be low-level formatted again.

3. When the screen shown below displays, select Format Disk and press <Enter>. The following screen appears:

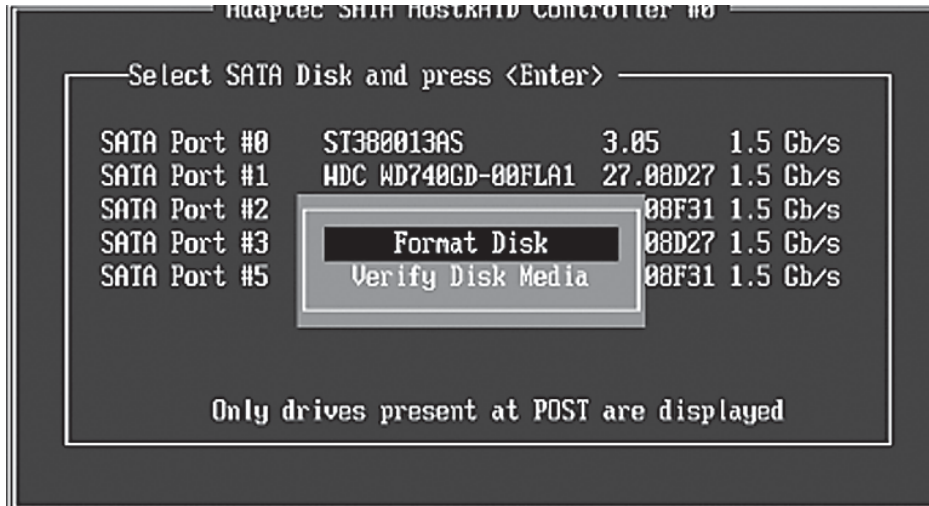

4. Read the warning message when it appears in the screen as shown below. To continue with disk formatting, select Yes and hit <Enter>. Otherwise, select No and press <Enter>.

(Caution: Formatting a disk destroys all data on the drive. Be sure to back up your data before formatting a disk.)

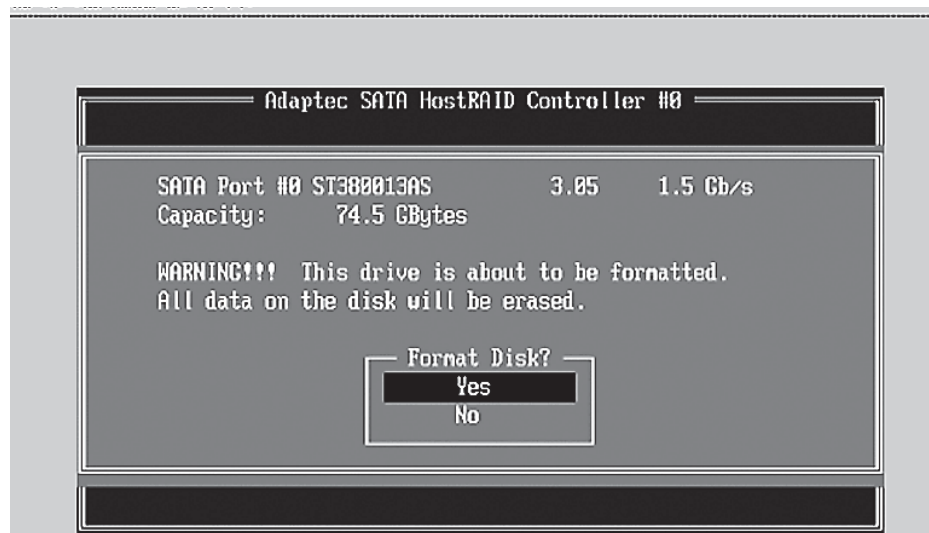

To verify disk media:

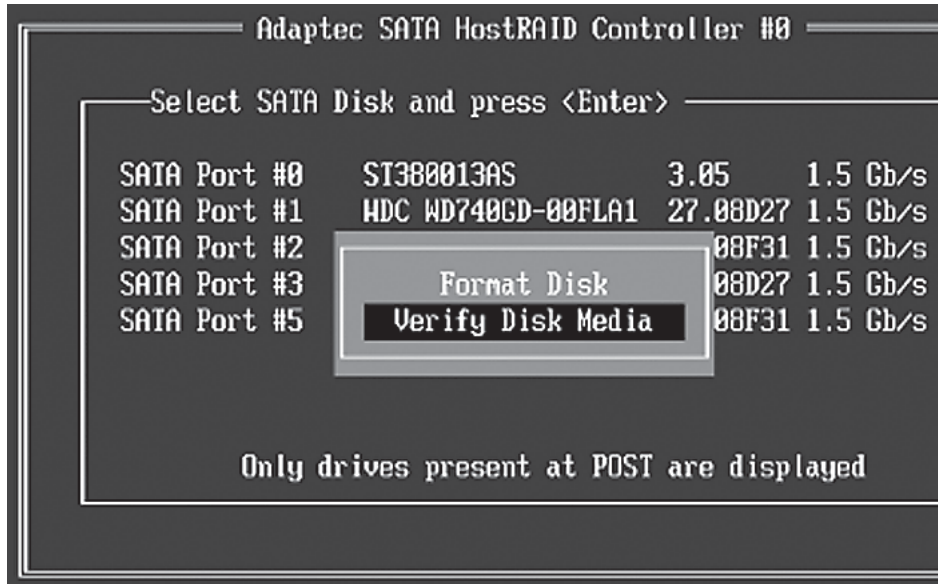

3 When the screen shown above displays, select Verify Disk Media and press <Enter>.

4 A message will display, indicating that the selected drive will be scanned for media defects. Select Yes and hit <Enter> to proceed with disk verifying; otherwise, select No and hit <Enter>.

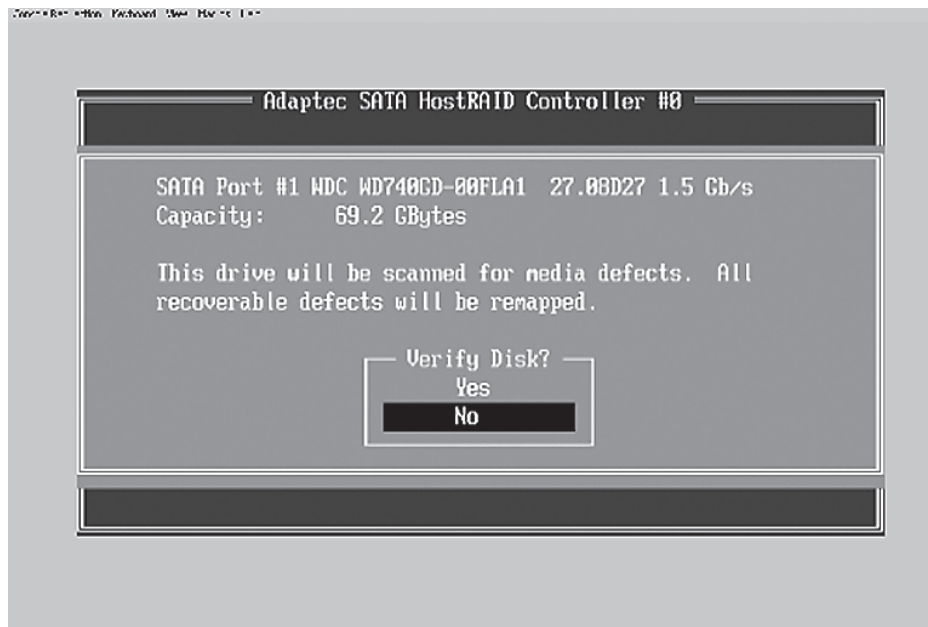

To Exit Adaptec RAID Configuration Utility

1. Once you have completed RAID array configurations, press ESC to exit. The following screen will appear.
2. Press Yes to exit the Utility.



D-2 Installing Intel's ESB2 Driver by Adaptec and Installing the OS

- a. Insert Supermicro's bootable CD that came with the package into the CD Drive during the system reboot, and the screen: "Super Micro Driver Diskette Maker" will appear.
- b. Choose from the list the item: "Intel ESB2 Driver by 3rd Party (Adaptec)" and press <ENTER>.
- c. From the next screen displayed, choose the OS driver you want to install and press <Enter>.
- d. Insert a formatted diskette into drive A: and press <Enter> as prompted.
- e. Exit the program after the process is completed. Then, reboot the system.
- f. Insert the Microsoft Windows OS Setup CD in the CD Driver, and the system will start to boot up from CD.
- g. Press the <F6> key when the message-"Press F6 if you need to install a third party SCSI or RAID driver" displays.
- h. When the Windows OS Setup screen appears, press "S" to specify additional device(s).
- i. Insert the driver diskette-"Adaptec Embedded Serial ATA Raid Controller Driver" into Drive A: and press the <Enter> key.
- j. Choose Adaptec Embedded Host Serial ATA Raid Controller from the list indicated in the Windows OS Setup Screen, and press the <Enter> key.
- k. Press the <Enter> key to continue the installation process. (If you need to specify any additional devices to be installed, do it at this time.) Once all devices are specified, press the <Enter> key to continue with the installation.
- l. From the Windows OS Setup screen, press <Enter>. The OS Setup will automatically load all device files, and, then, continue with the Windows OS installation.
- m. After the Windows OS Installation is completed, the system will automatically reboot.

Appendix E

Installing Other Software Programs and Drivers

E-1 Installing Drivers other than the Adaptec Embedded Serial ATA RAID Controller Driver

After you've installed the Windows Operating System, a screen as shown below will appear. You are ready to install software programs and drivers that have not yet been installed. To install these software programs and drivers, click the icons to the right of these items.

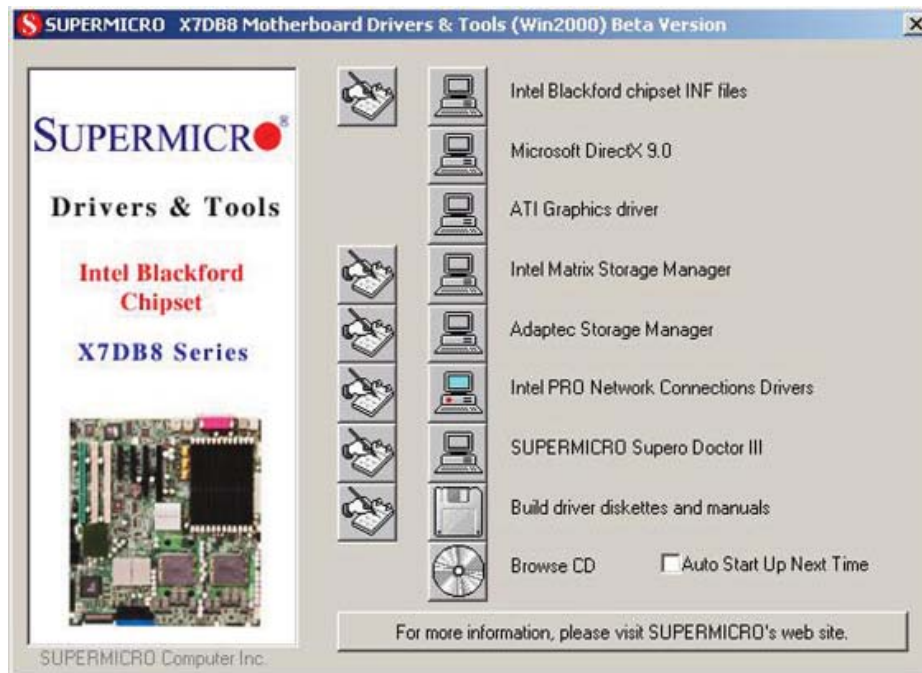

Driver/Tool Installation Display Screen

Note: Click the icons showing a hand writing on the paper to view the readme files for each item. Click a computer icon to the right of an item (from top to the bottom) one at a time. **After installing each item, you must re-boot the system before proceeding with the next item on the list.** The bottom icon with a CD on it allows you to view the entire contents of the CD.

E-2 Configuring Supero Doctor III

The Supero Doctor III program is a Web-base management tool that supports remote management capability. It includes Remote and Local Management tools. The local management is called the SD III Client. The Supero Doctor III program included on the CDROM that came with your motherboard allows you to monitor the environment and operations of your system. Supero Doctor III displays crucial system information such as CPU temperature, system voltages and fan status. See the Figure below for a display of the Supero Doctor III interface.

Note 1: The default user name and password are ADMIN.

Note 2: In the Windows OS environment, the Supero Doctor III settings take precedence over the BIOS settings. When first installed, Supero Doctor III adopts the temperature threshold settings previously set in the BIOS. Any subsequent changes to these thresholds must be made within Supero Doctor, since the SD III settings override the BIOS settings. For the Windows OS to adopt the BIOS temperature threshold settings, please change the SDIII settings to be the same as those set in the BIOS.

Supero Doctor III Interface Display Screen-I (Health Information)

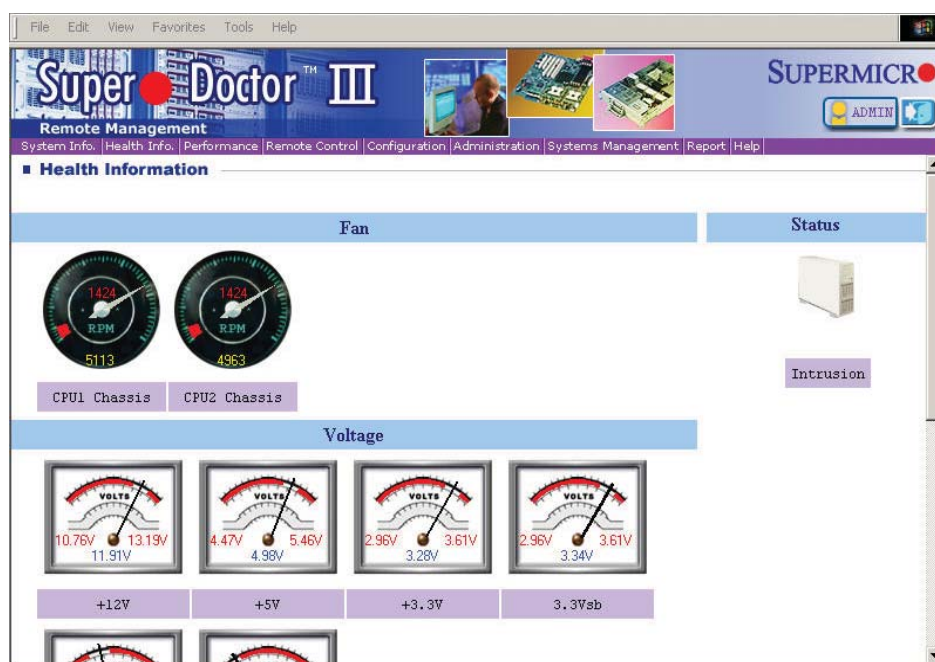

Supero Doctor III Interface Display Screen-II (Remote Control)



Note: SD III Software Revision 1.0 can be downloaded from our Web site at: ftp://ftp.supermicro.com/utility/Supero_Doctor_III/. You can also download SDIII User's Guide at: <http://www.supermicro.com/PRODUCT/Manuals/SDIII/UserGuide.pdf>. For Linux, we will still recommend that you use Supero Doctor II.

Disclaimer

The products sold by Supermicro are not intended for and will not be used in life support systems, medical equipment, nuclear facilities or systems, aircraft, aircraft devices, aircraft/emergency communication devices or other critical systems whose failure to perform be reasonably expected to result in significant injury or loss of life or catastrophic property damage. Accordingly, Supermicro disclaims any and all liability, and should buyer use or sell such products for use in such ultra-hazardous applications, it does so entirely at its own risk. Furthermore, buyer agrees to fully indemnify, defend and hold Supermicro harmless for and against any and all claims, demands, actions, litigation, and proceedings of any kind arising out of or related to such ultra-hazardous use or sale.